

# PRZEKROJE POPRZECZNE DROGI WOJEWÓDZKIEJ NR 655 OD KM 101+819 DO KM 102+800

SKALA 1:10/100

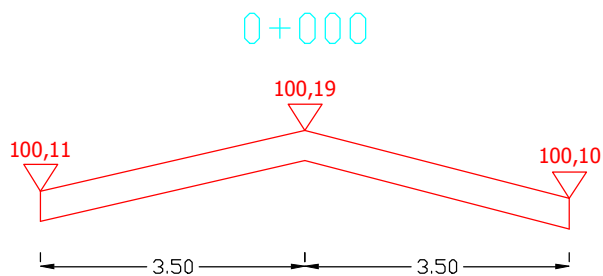

Pwyr.=0,0000 m<sup>2</sup>

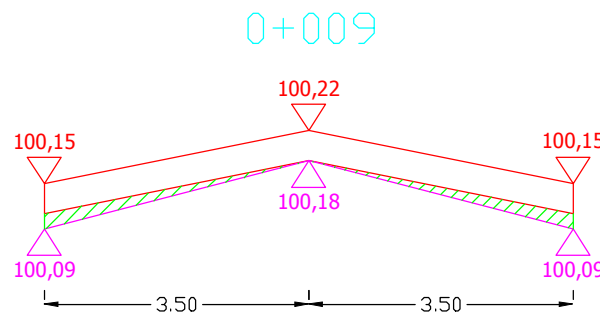

Pwyr.=0,0700 m<sup>2</sup>

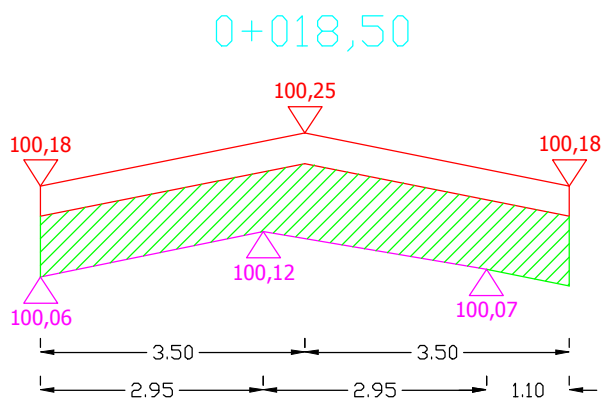

Pwyr.=0,6144 m<sup>2</sup>

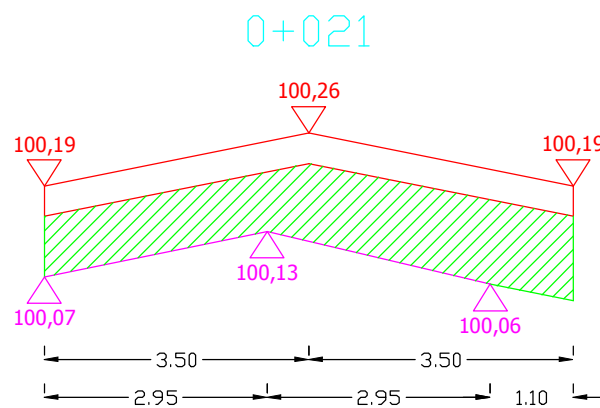

Pwyr.=0,6659 m<sup>2</sup>

Sporządził:

PRZEKROJE POPRZECZNE DROGI WOJEWÓDZKIEJ NR 655 OD KM 101+819 DO KM 102+800

SKALA 1:10/100

0+031

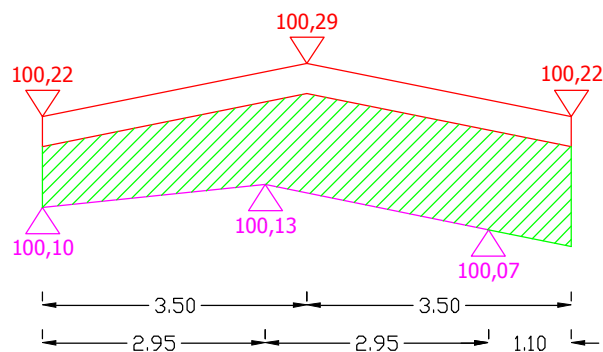

Pwyr.=0,8059 m<sup>2</sup>

0+041

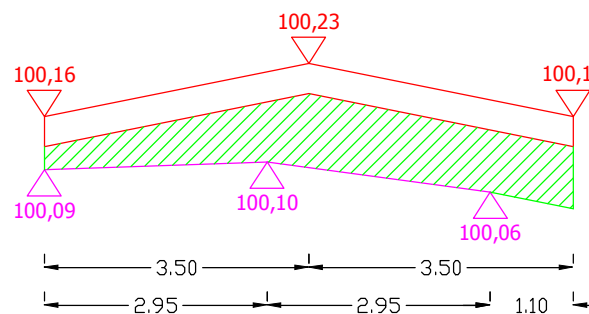

Pwyr.=0,5149 m<sup>2</sup>

0+051

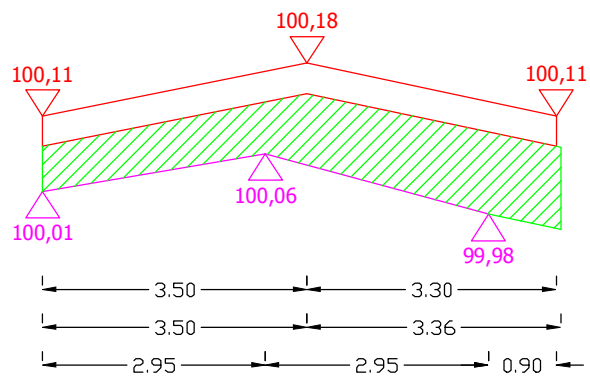

Pwyr.=0,5849 m<sup>2</sup>

0+061

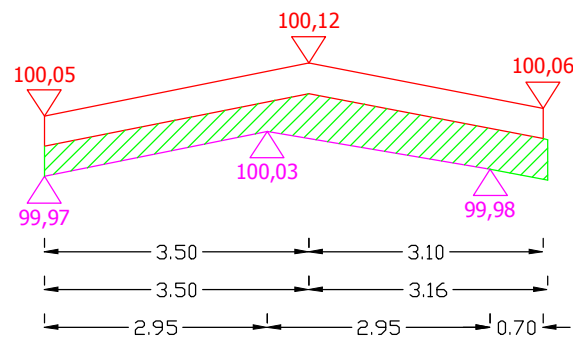

Pwyr.=0,3197 m<sup>2</sup>

Sporządził:

PRZEKROJE POPRZECZNE DROGI WOJEWÓDZKIEJ NR 655 OD KM 101+819 DO KM 102+800

SKALA 1:10/100

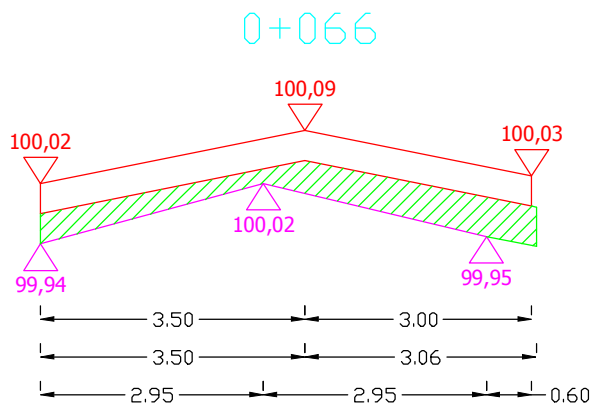

Pwyr.=0,2525 m<sup>2</sup>

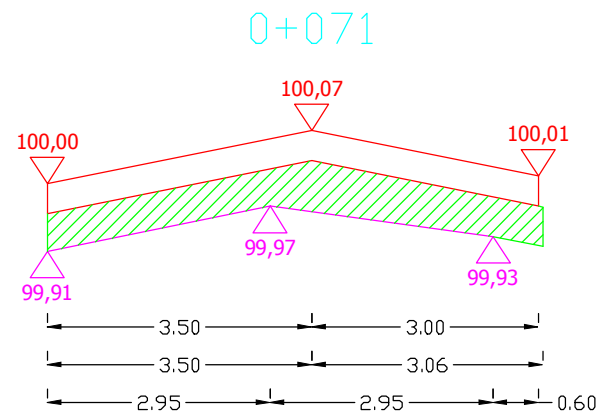

Pwyr.=0,3557 m<sup>2</sup>

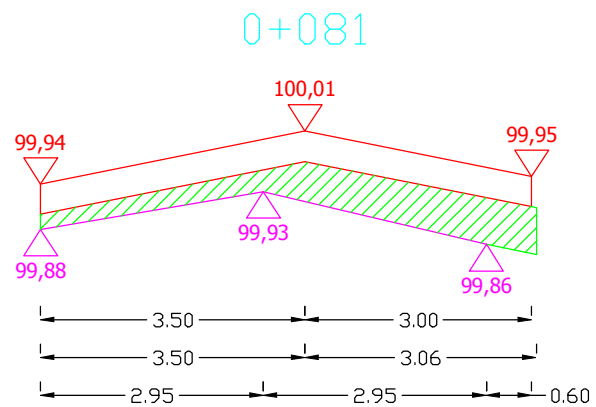

Pwyr.=0,2738 m<sup>2</sup>

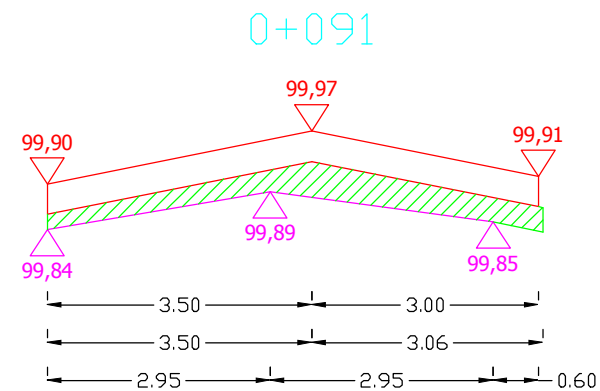

Pwyr.=0,2098 m<sup>2</sup>

Sporządził:

PRZEKROJE POPRZECZNE DROGI WOJEWÓDZKIEJ NR 655 OD KM 101+819 DO KM 102+800

SKALA 1:10/100

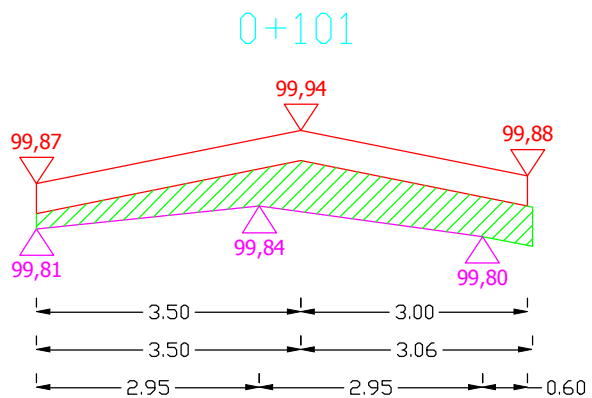

Pwyr.=0,3115 m<sup>2</sup>

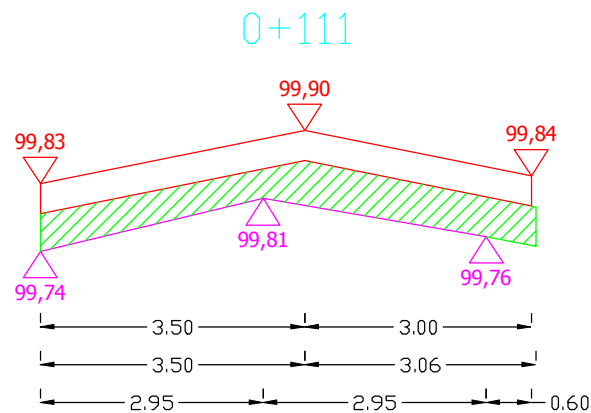

Pwyr.=0,3262 m<sup>2</sup>

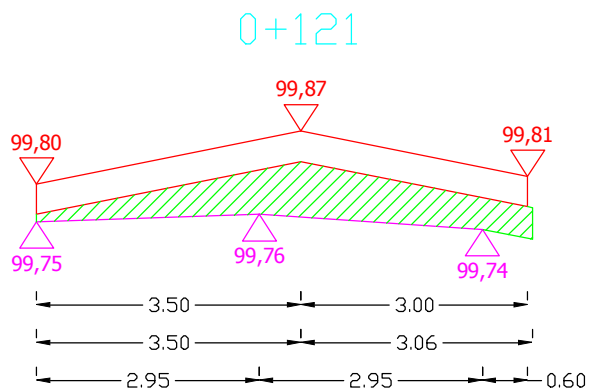

Pwyr.=0,3049 m<sup>2</sup>

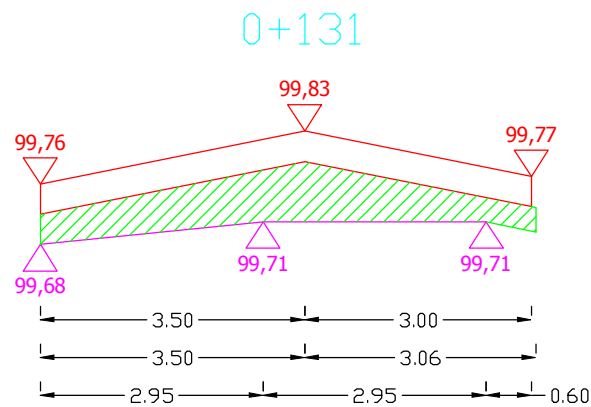

Pwyr.=0,3573 m<sup>2</sup>

Sporządził:

PRZEKROJE POPRZECZNE DROGI WOJEWÓDZKIEJ NR 655 OD KM 101+819 DO KM 102+800

SKALA 1:10/100

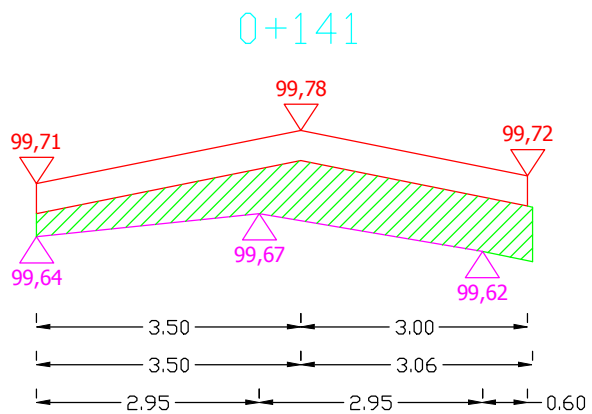

Pwyr.=0,3984 m<sup>2</sup>

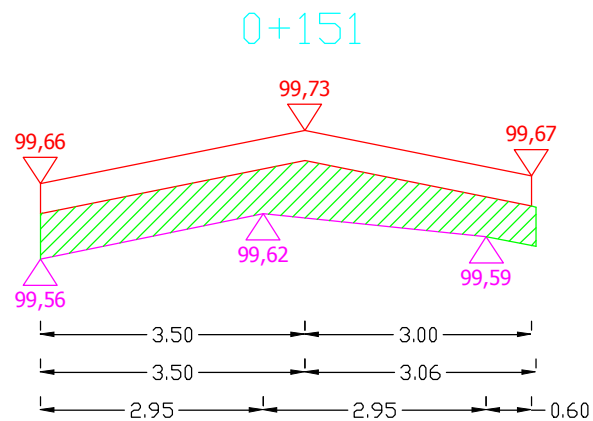

Pwyr.=0,4000 m<sup>2</sup>

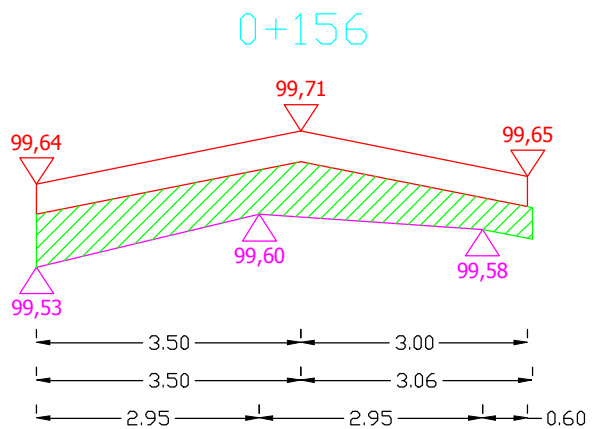

Pwyr.=0,3934 m<sup>2</sup>

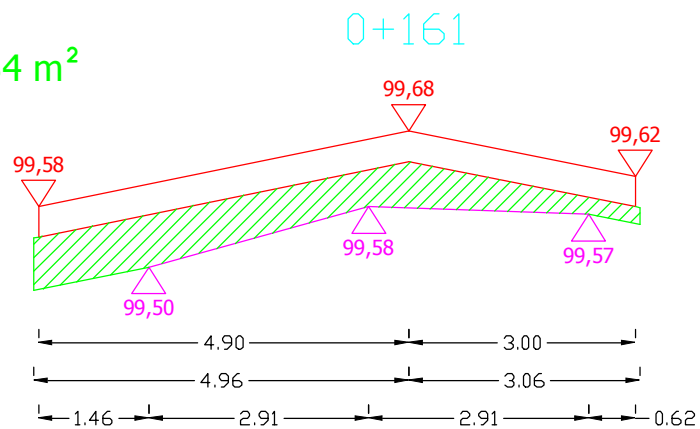

Pwyr.=0,4241 m<sup>2</sup>

Sporządził:

PRZEKROJE POPRZECZNE DROGI WOJEWÓDZKIEJ NR 655 OD KM 101+819 DO KM 102+800

SKALA 1:10/100

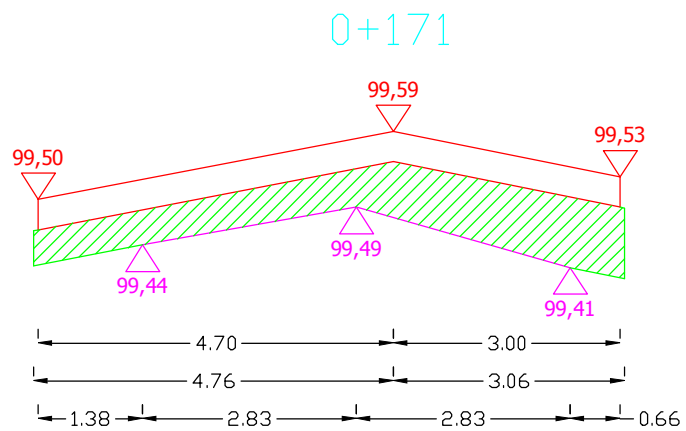

Pwyr.=0,4972 m<sup>2</sup>

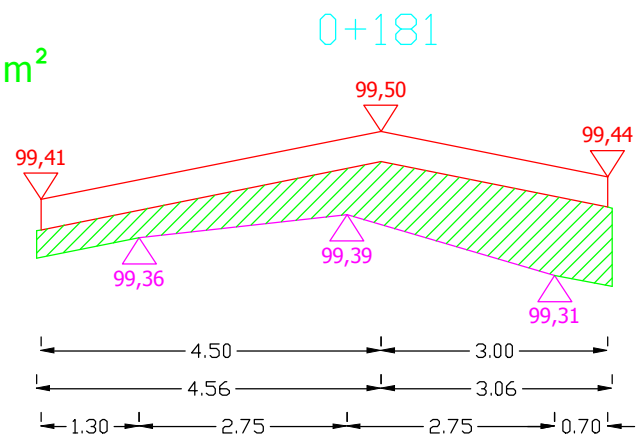

Pwyr.=0,5090 m<sup>2</sup>

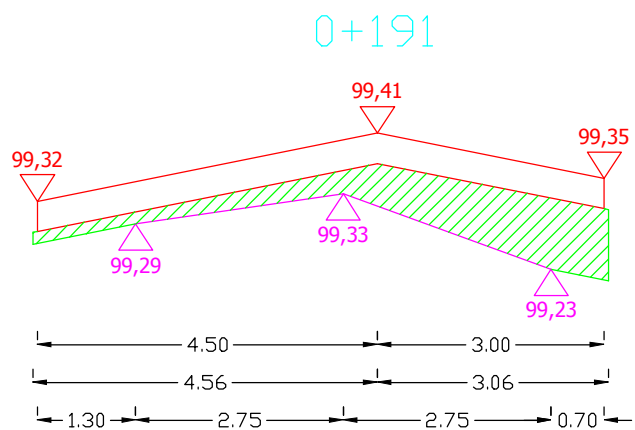

Pwyr.=0,3504 m<sup>2</sup>

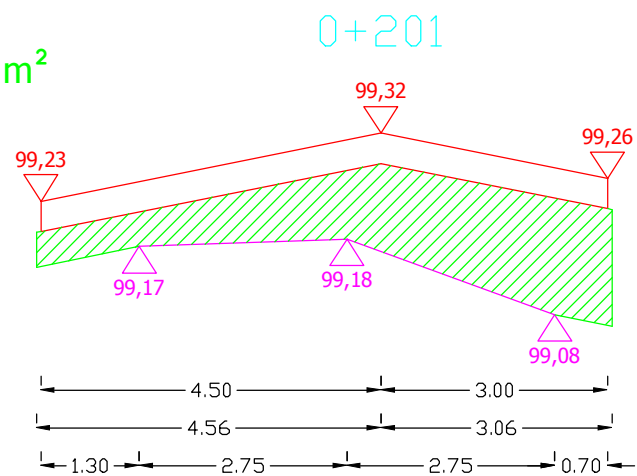

Pwyr.=0,7256 m<sup>2</sup>

Sporządził:

# PRZEKROJE POPRZECZNE DROGI WOJEWÓDZKIEJ NR 655 OD KM 101+819 DO KM 102+800

SKALA 1:10/100

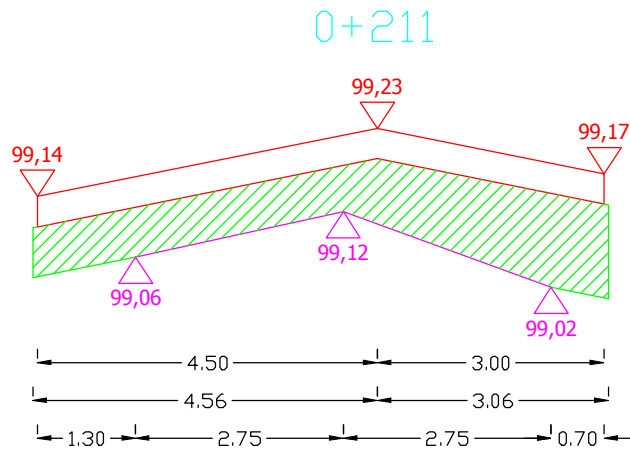

Pwyr.=0,6337 m<sup>2</sup>

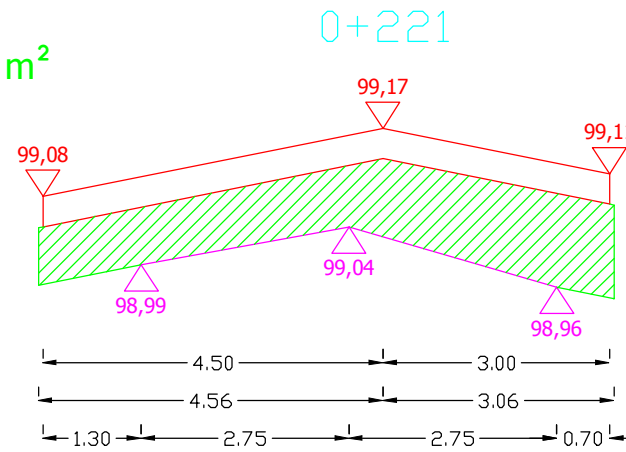

Pwyr.=0,7161 m<sup>2</sup>

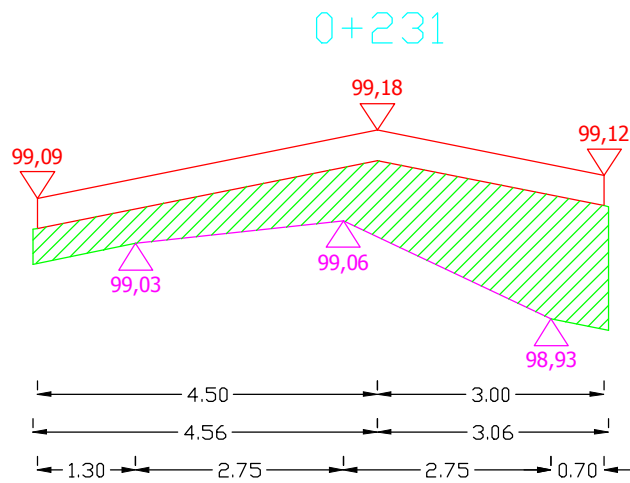

Pwyr.=0,6919 m<sup>2</sup>

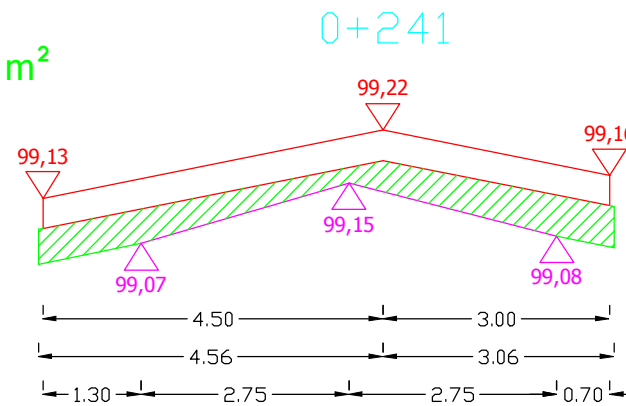

Pwyr.=0,3196 m<sup>2</sup>

Sporządził:

PRZEKROJE POPRZECZNE DROGI WOJEWÓDZKIEJ NR 655 OD KM 101+819 DO KM 102+800

SKALA 1:10/100

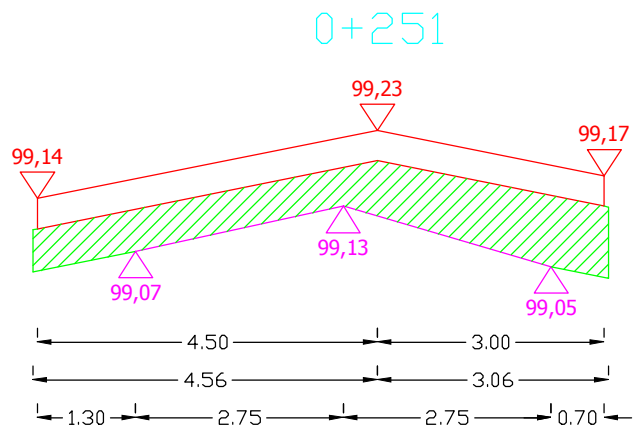

Pwyr.=0,5148 m<sup>2</sup>

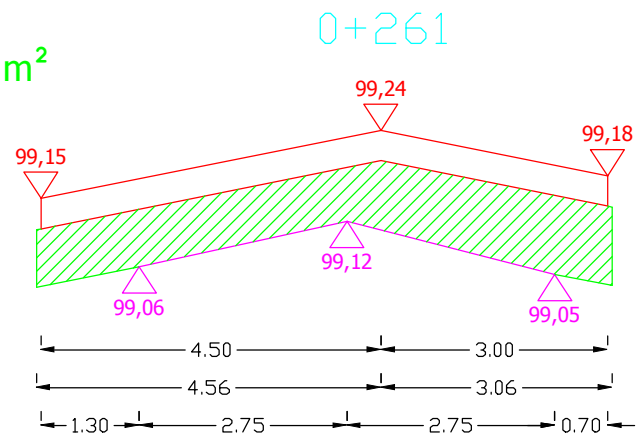

Pwyr.=0,6459 m<sup>2</sup>

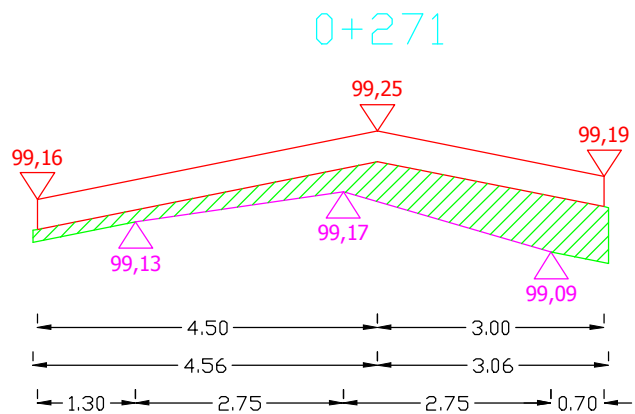

Pwyr.=0,3077 m<sup>2</sup>

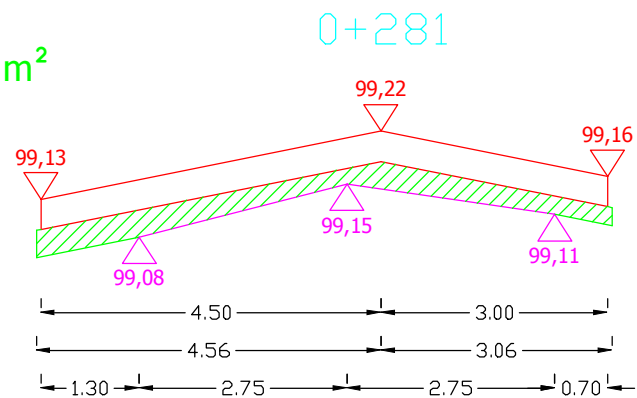

Pwyr.=0,2282 m<sup>2</sup>

Sporządził:



PRZEKROJE POPRZECZNE DROGI WOJEWÓDZKIEJ NR 655 OD KM 101+819 DO KM 102+800

SKALA 1:10/100

0+291

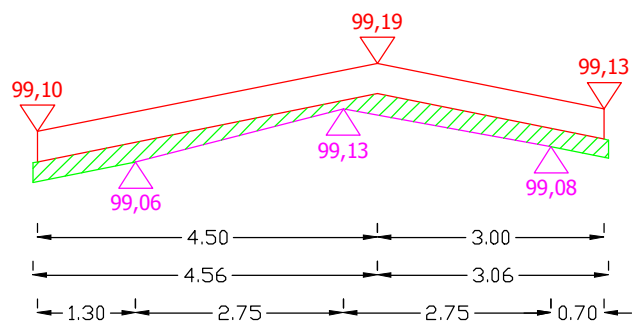

Pwyr.=0,1733 m<sup>2</sup>

0+301

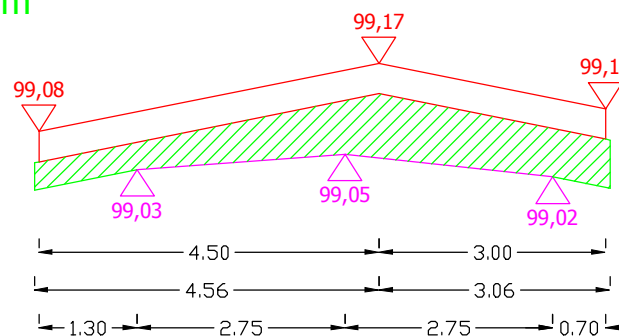

Pwyr.=0,4511 m<sup>2</sup>

0+311

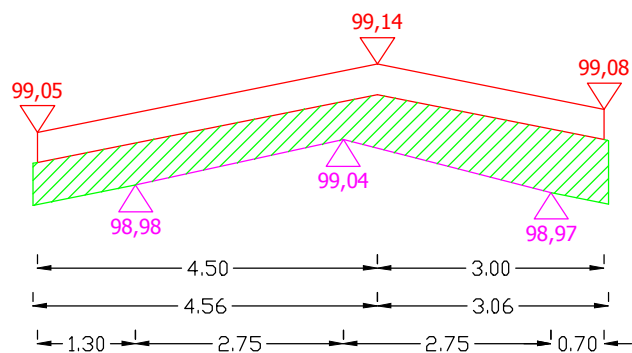

Pwyr.=0,4935 m<sup>2</sup>

0+321

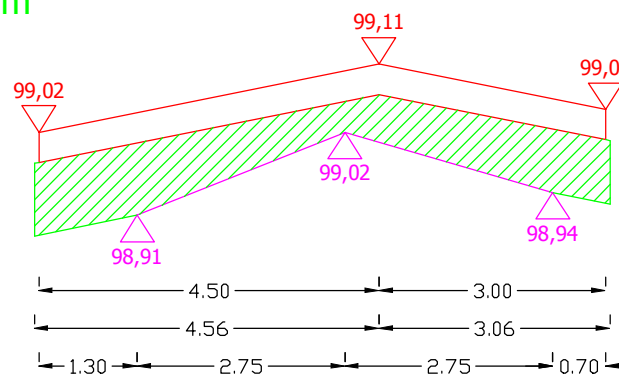

Pwyr.=0,5754 m<sup>2</sup>

Sporządził:

PRZEKROJE POPRZECZNE DROGI WOJEWÓDZKIEJ NR 655 OD KM 101+819 DO KM 102+800

SKALA 1:10/100

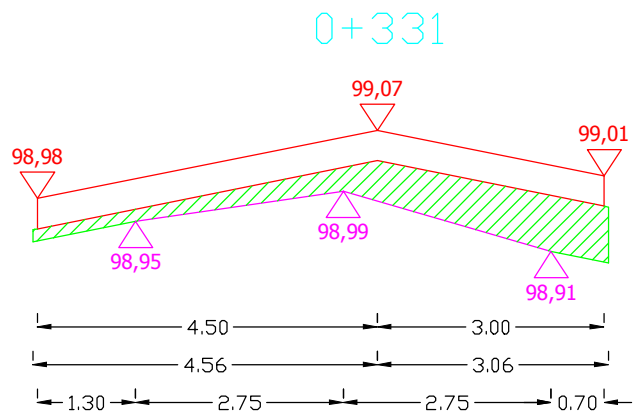

Pwyr.=0,3077 m<sup>2</sup>

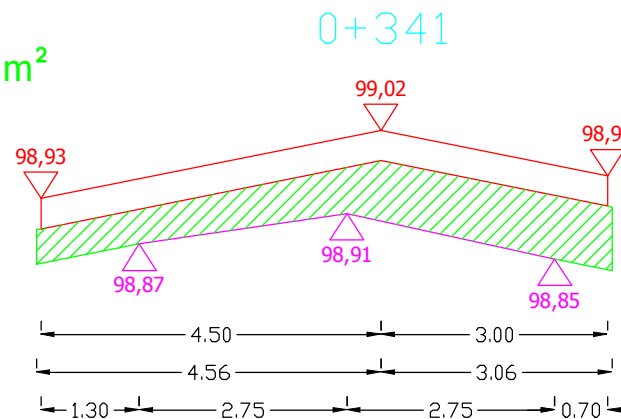

Pwyr.=0,4936 m<sup>2</sup>

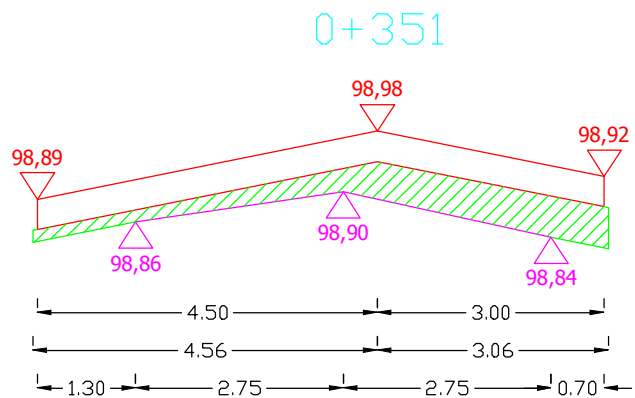

Pwyr.=0,2650 m<sup>2</sup>

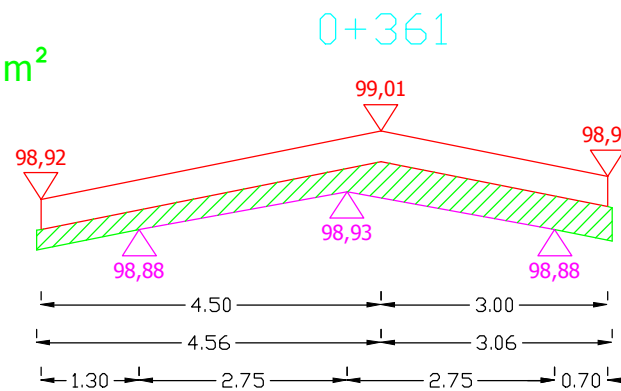

Pwyr.=0,2710 m<sup>2</sup>

Sporządził:

# PRZEKROJE POPRZECZNE DROGI WOJEWÓDZKIEJ NR 655 OD KM 101+819 DO KM 102+800

SKALA 1:10/100

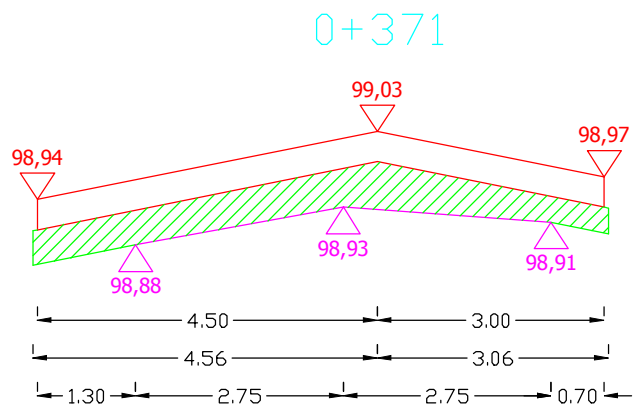

Pwyr.=0,3594 m<sup>2</sup>

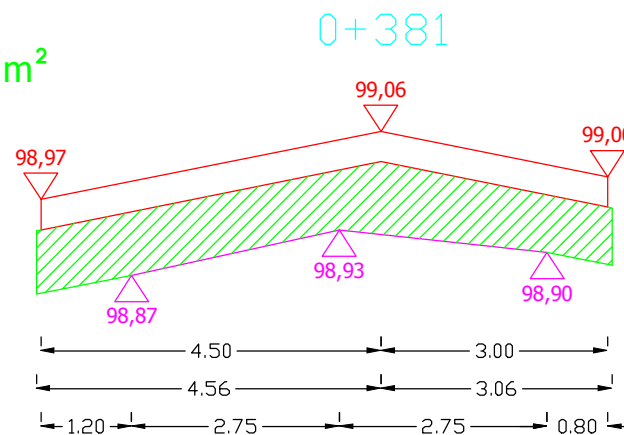

Pwyr.=0,6327 m<sup>2</sup>

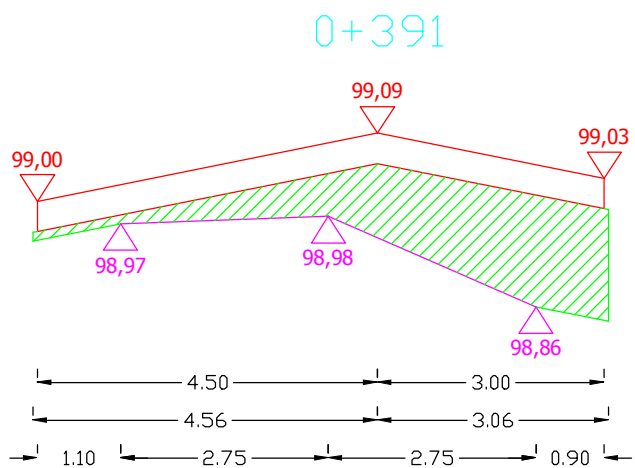

Pwyr.=0,5601 m<sup>2</sup>

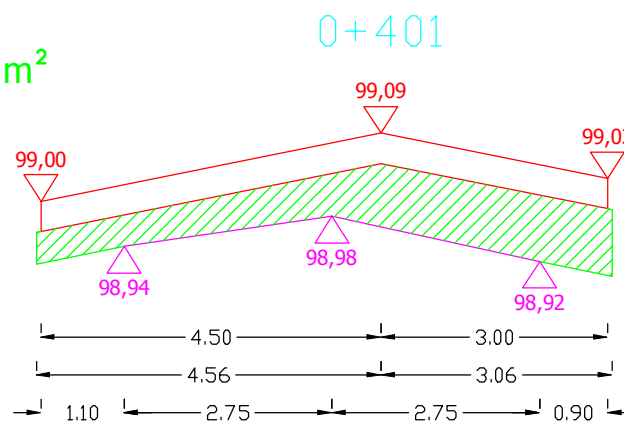

Pwyr.=0,4960 m<sup>2</sup>

Sporządził:

PRZEKROJE POPRZECZNE DROGI WOJEWÓDZKIEJ NR 655 OD KM 101+819 DO KM 102+800

SKALA 1:10/100

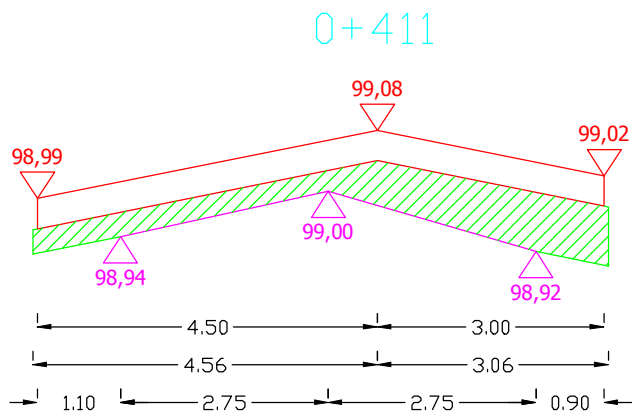

Pwyr.=0,3648 m<sup>2</sup>

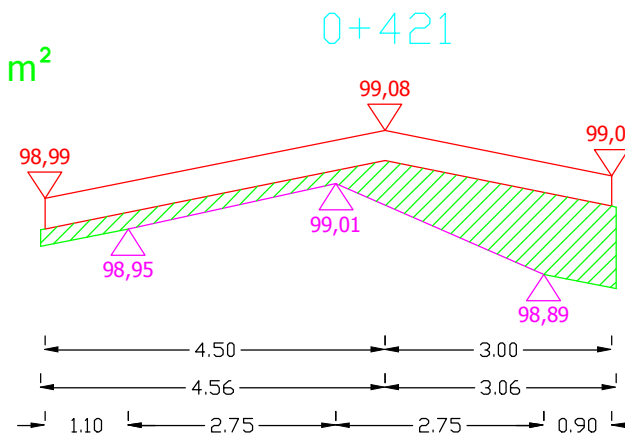

Pwyr.=0,3820 m<sup>2</sup>

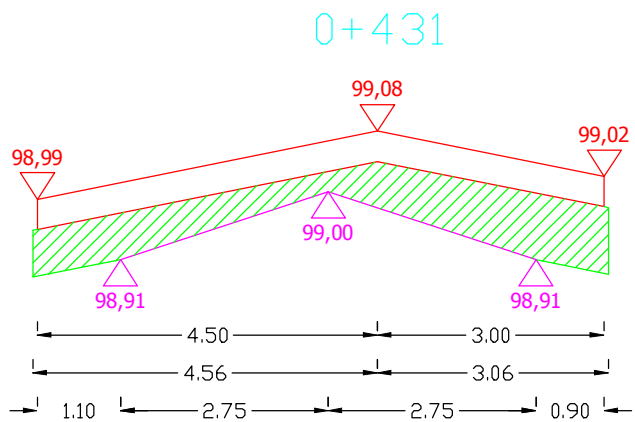

Pwyr.=0,4642 m<sup>2</sup>

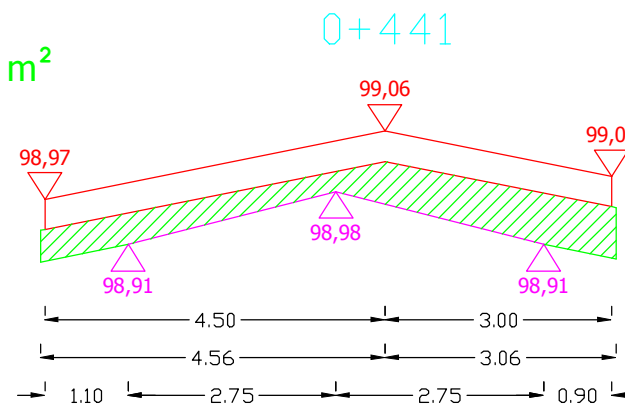

Pwyr.=0,3668 m<sup>2</sup>

Sporządził:

PRZEKROJE POPRZECZNE DROGI WOJEWÓDZKIEJ NR 655 OD KM 101+819 DO KM 102+800

SKALA 1:10/100

0+451

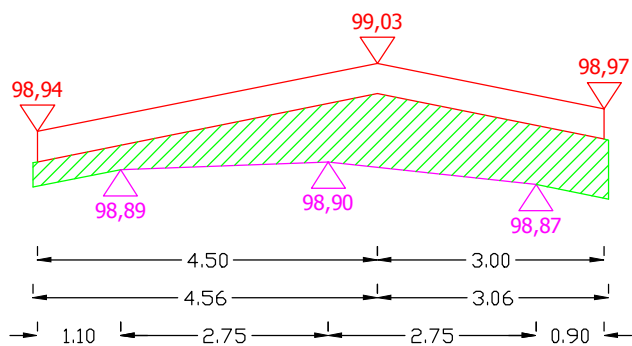

Pwyr.=0,5023 m<sup>2</sup>

0+461

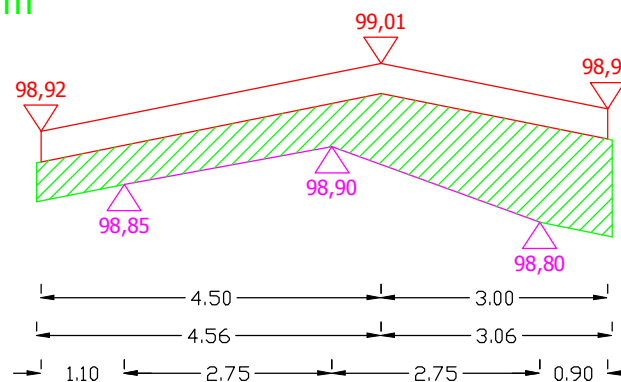

Pwyr.=0,6148 m<sup>2</sup>

0+471

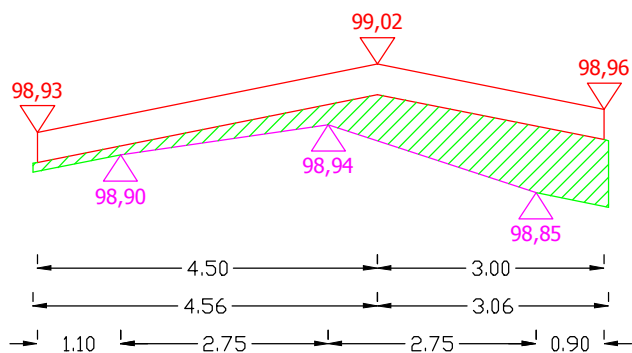

Pwyr.=0,3375 m<sup>2</sup>

0+481

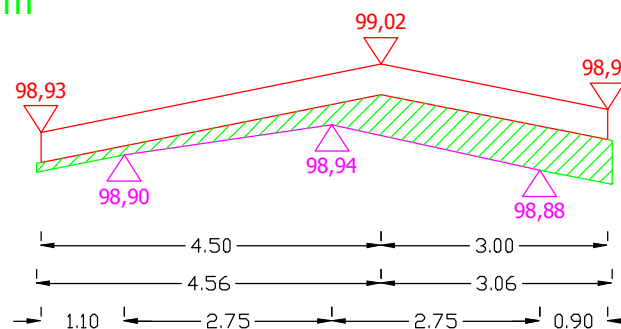

Pwyr.=0,2674 m<sup>2</sup>

Sporządził:

# PRZEKROJE POPRZECZNE DROGI WOJEWÓDZKIEJ NR 655 OD KM 101+819 DO KM 102+800

SKALA 1:10/100

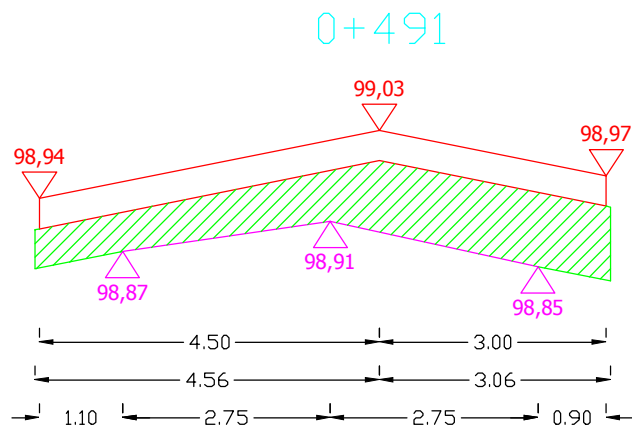

Pwyr.=0,5722 m<sup>2</sup>

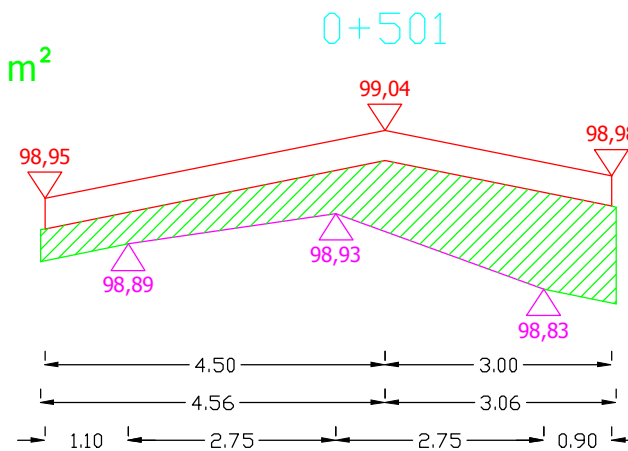

Pwyr.=0,5894 m<sup>2</sup>

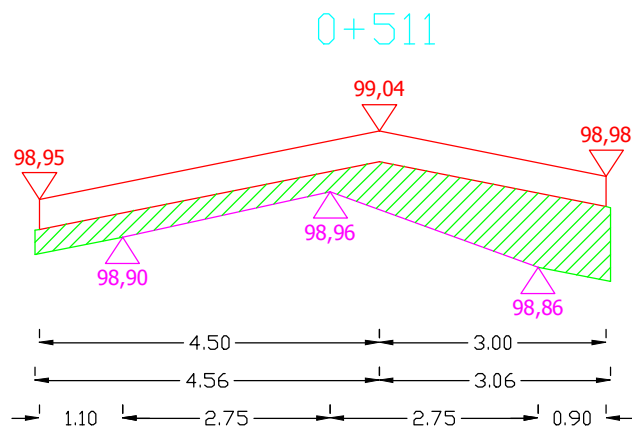

Pwyr.=0,4115 m<sup>2</sup>

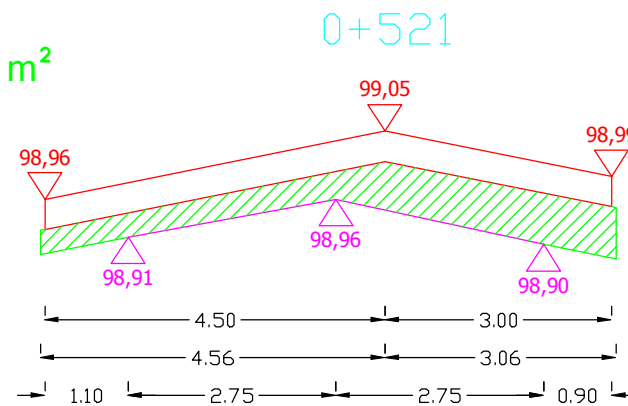

Pwyr.=0,3690 m<sup>2</sup>

Sporządził:

# PRZEKROJE POPRZECZNE DROGI WOJEWÓDZKIEJ NR 655 OD KM 101+819 DO KM 102+800

SKALA 1:10/100

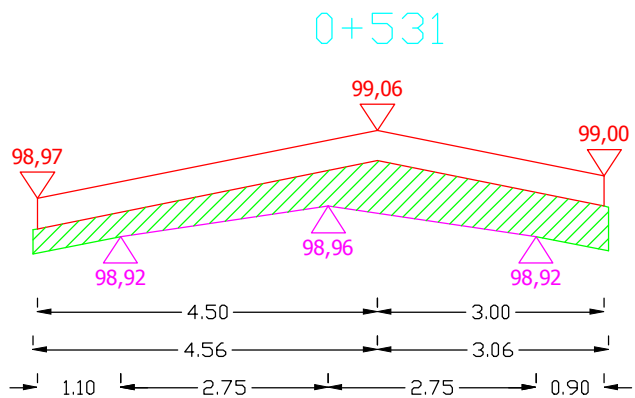

Pwyr.=0,3731 m<sup>2</sup>

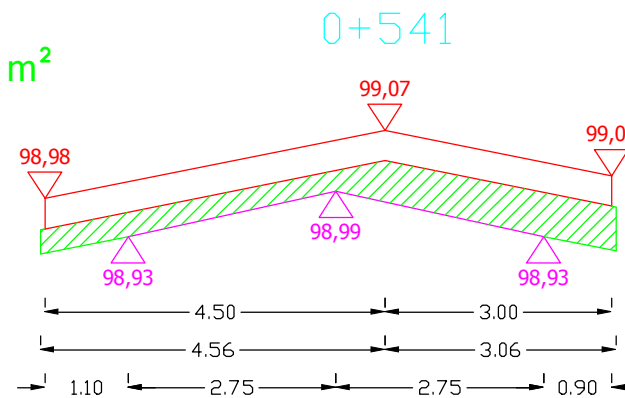

Pwyr.=0,3181 m<sup>2</sup>

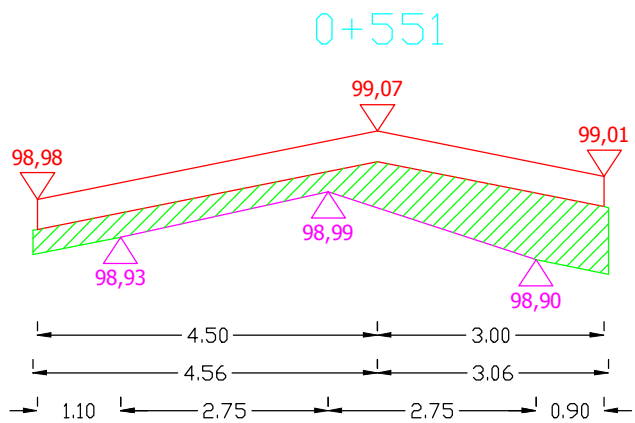

Pwyr.=0,3882 m<sup>2</sup>

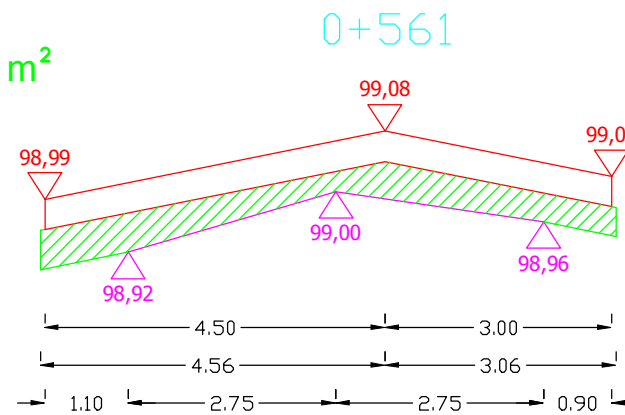

Pwyr.=0,3221 m<sup>2</sup>

Sporządził:

PRZEKROJE POPRZECZNE DROGI WOJEWÓDZKIEJ NR 655 OD KM 101+819 DO KM 102+800

SKALA 1:10/100

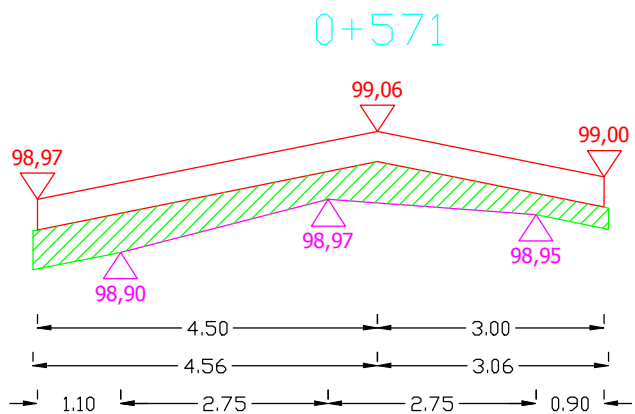

Pwyr.=0,3263 m<sup>2</sup>

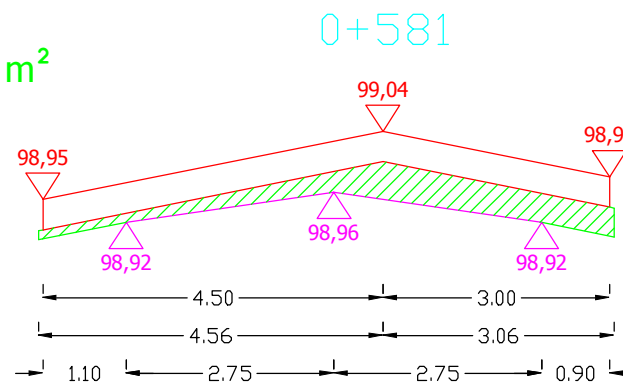

Pwyr.=0,2207 m<sup>2</sup>

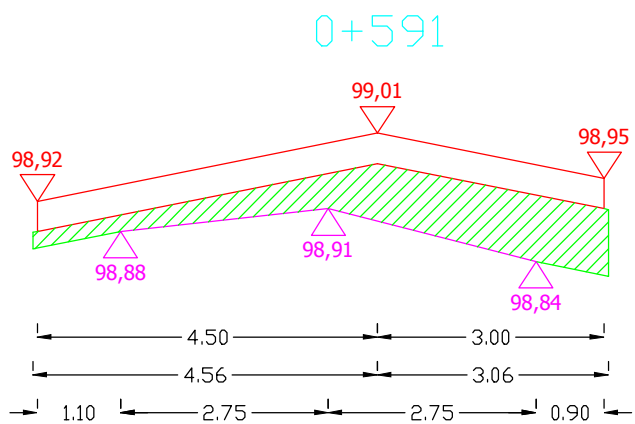

Pwyr.=0,4178 m<sup>2</sup>

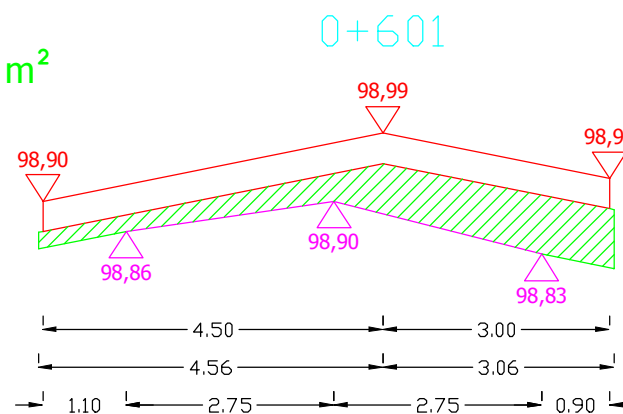

Pwyr.=0,3670 m<sup>2</sup>

Sporządził:



PRZEKROJE POPRZECZNE DROGI WOJEWÓDZKIEJ NR 655 OD KM 101+819 DO KM 102+800

SKALA 1:10/100

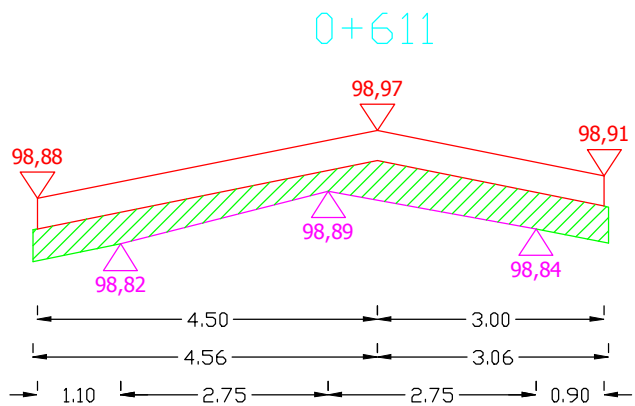

Pwyr.=0,3201 m<sup>2</sup>

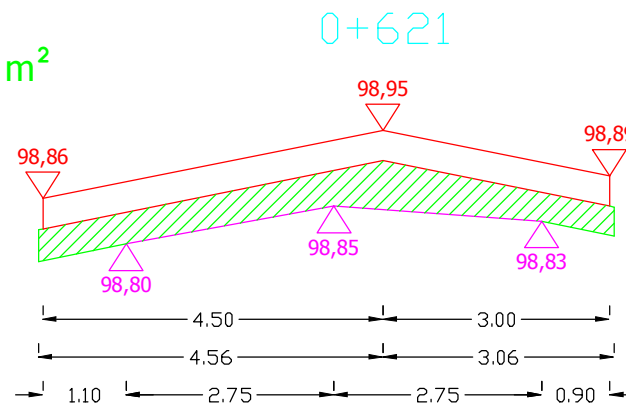

Pwyr.=0,3518 m<sup>2</sup>

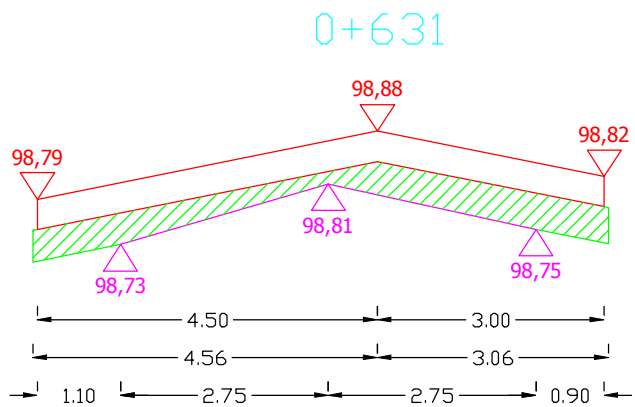

Pwyr.=0,2926 m<sup>2</sup>

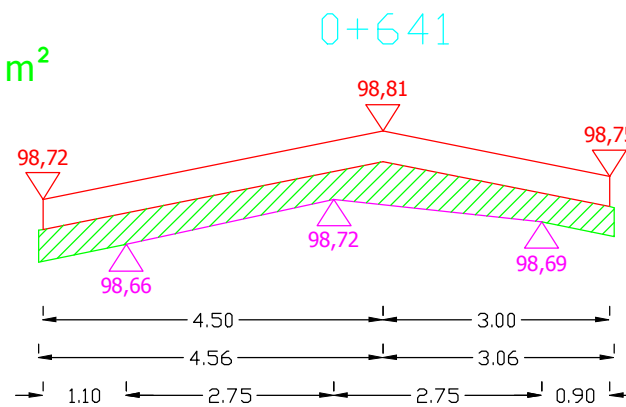

Pwyr.=0,3243 m<sup>2</sup>

Sporządził:

# PRZEKROJE POPRZECZNE DROGI WOJEWÓDZKIEJ NR 655 OD KM 101+819 DO KM 102+800

SKALA 1:10/100

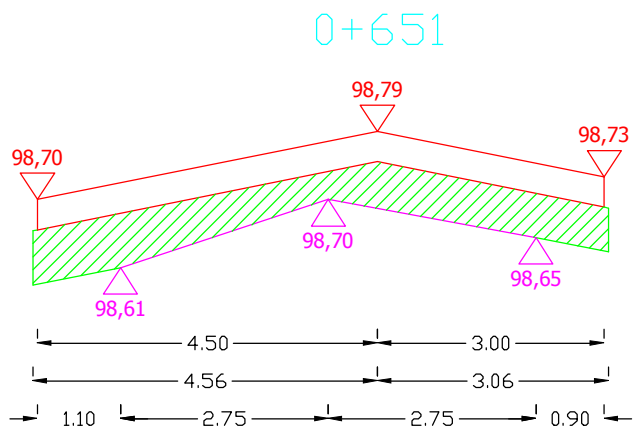

Pwyr.=0,4470 m<sup>2</sup>

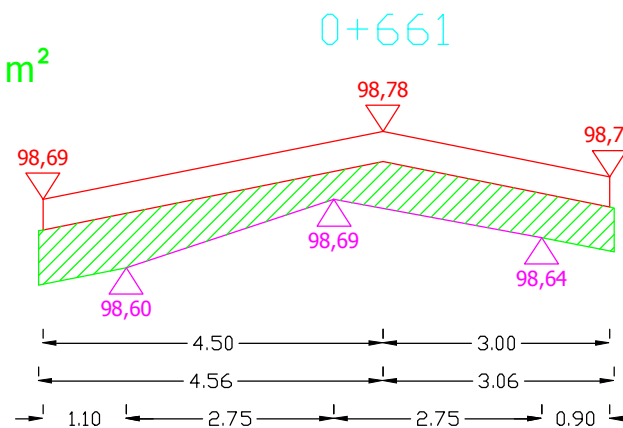

Pwyr.=0,4470 m<sup>2</sup>

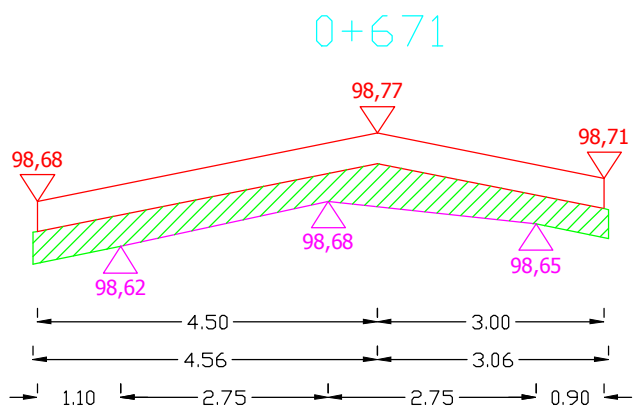

Pwyr.=0,3243 m<sup>2</sup>

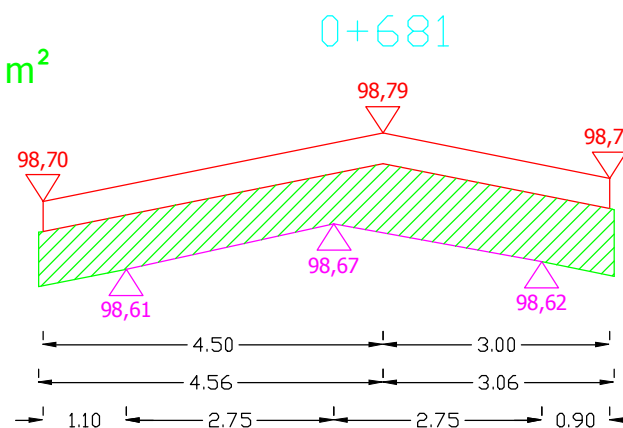

Pwyr.=0,5996 m<sup>2</sup>

Sporządził:

PRZEKROJE POPRZECZNE DROGI WOJEWÓDZKIEJ NR 655 OD KM 101+819 DO KM 102+800

SKALA 1:10/100

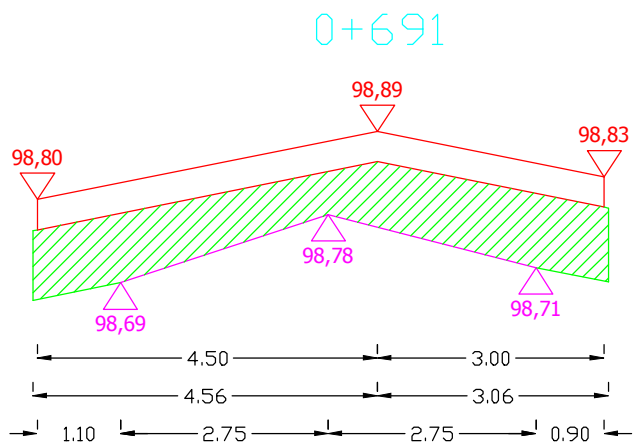

Pwyr.=0,6461 m<sup>2</sup>

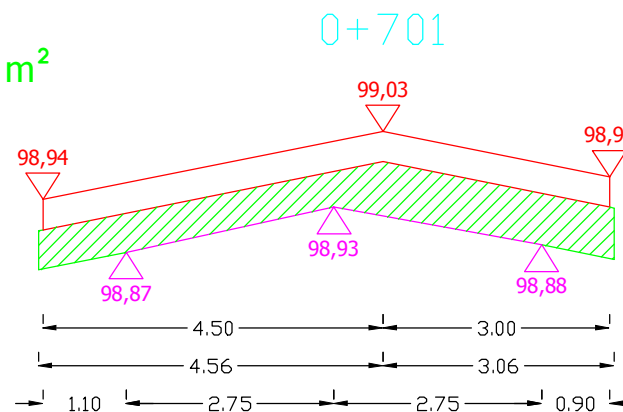

Pwyr.=0,4472 m<sup>2</sup>

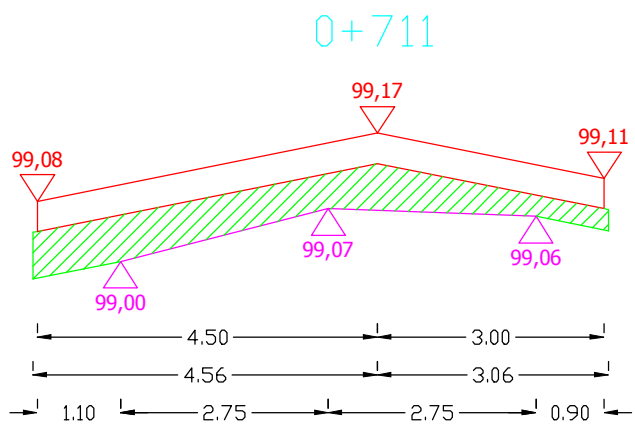

Pwyr.=0,3791 m<sup>2</sup>

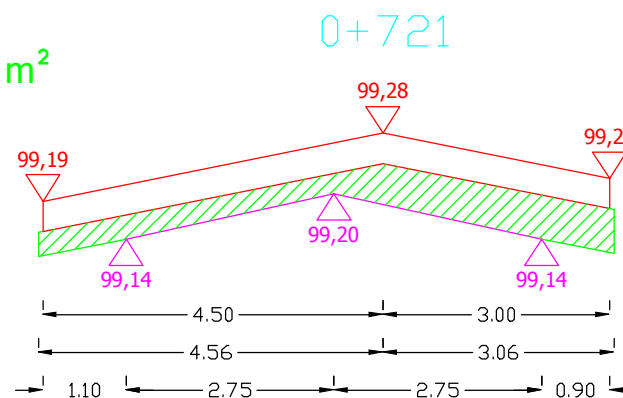

Pwyr.=0,3181 m<sup>2</sup>

Sporządził:

PRZEKROJE POPRZECZNE DROGI WOJEWÓDZKIEJ NR 655 OD KM 101+819 DO KM 102+800

SKALA 1:10/100

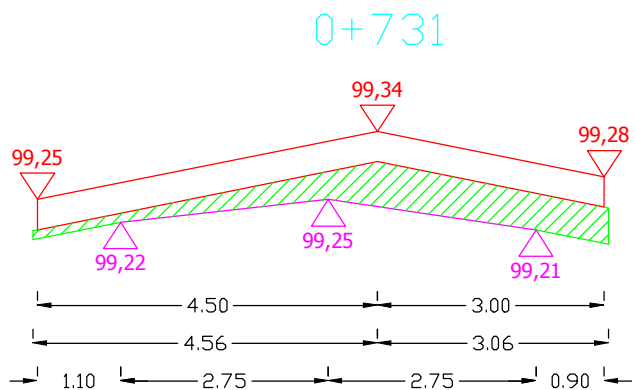

Pwyr.=0,2716 m<sup>2</sup>

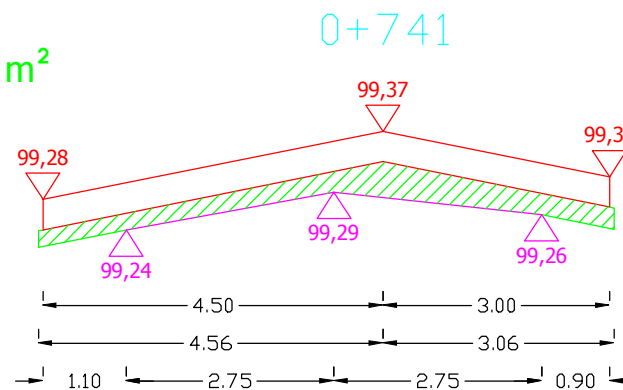

Pwyr.=0,2207 m<sup>2</sup>

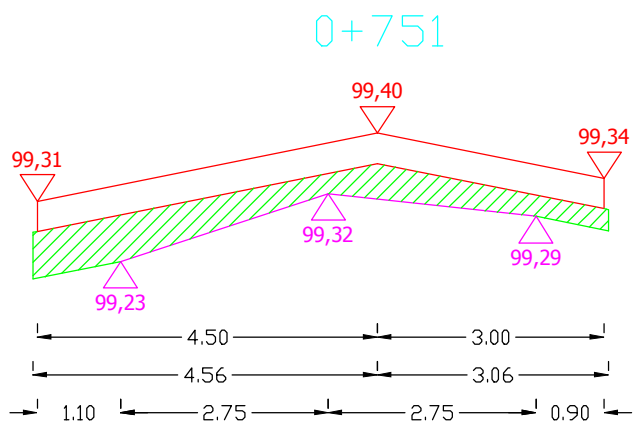

Pwyr.=0,3241 m<sup>2</sup>

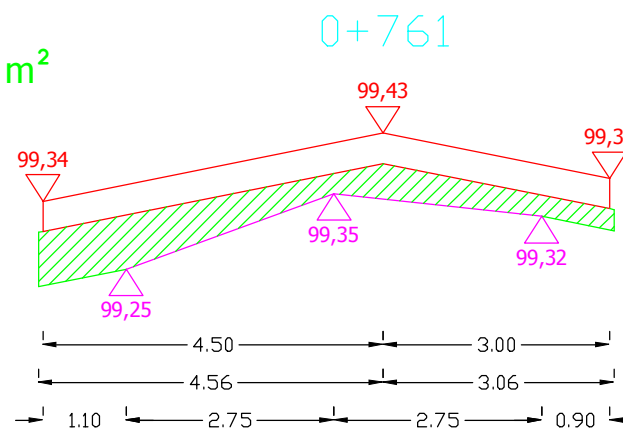

Pwyr.=0,3495 m<sup>2</sup>

Sporządził:

PRZEKROJE POPRZECZNE DROGI WOJEWÓDZKIEJ NR 655 OD KM 101+819 DO KM 102+800

SKALA 1:10/100

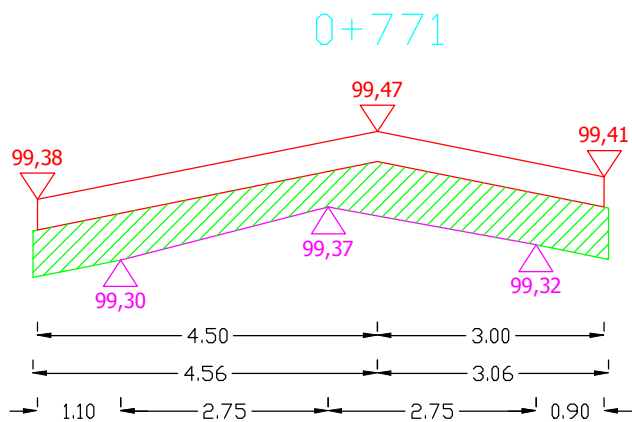

Pwyr.=0,4725 m<sup>2</sup>

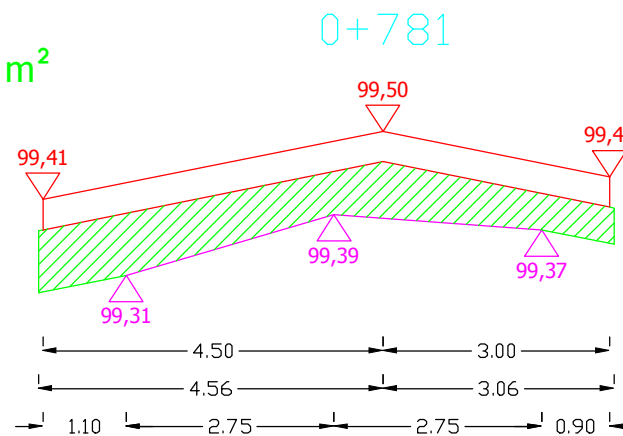

Pwyr.=0,5040 m<sup>2</sup>

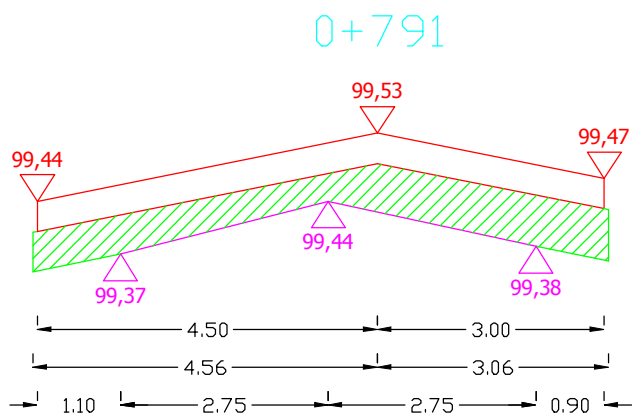

Pwyr.=0,4197 m<sup>2</sup>

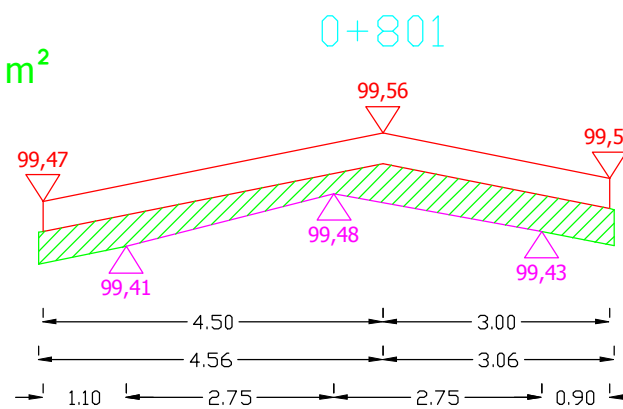

Pwyr.=0,3201 m<sup>2</sup>

Sporządził:

# PRZEKROJE POPRZECZNE DROGI WOJEWÓDZKIEJ NR 655 OD KM 101+819 DO KM 102+800

SKALA 1:10/100

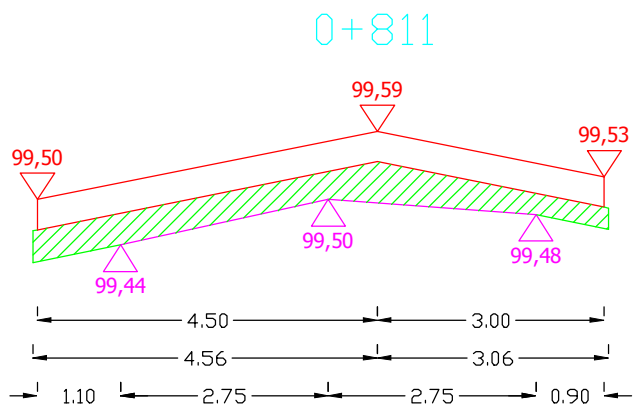

Pwyr.=0,3009 m<sup>2</sup>

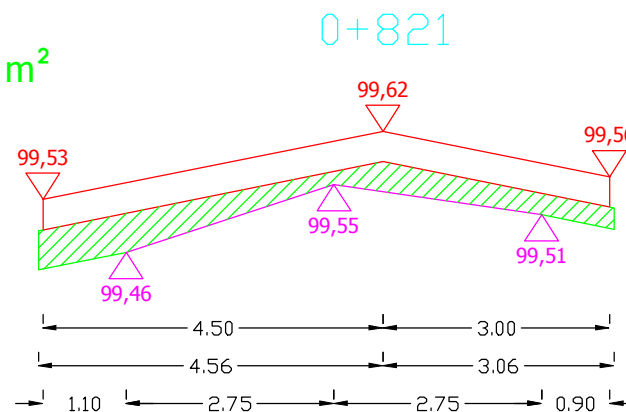

Pwyr.=0,2713 m<sup>2</sup>

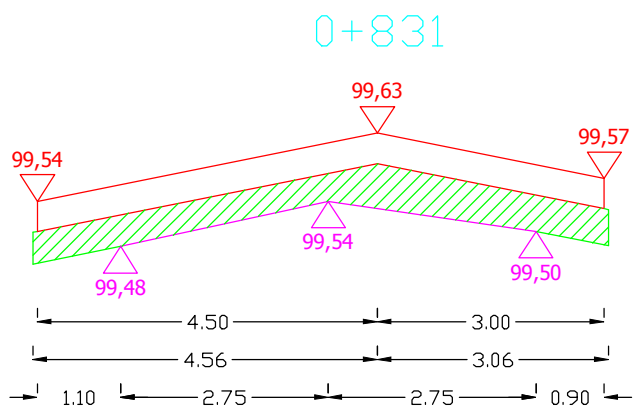

Pwyr.=0,3476 m<sup>2</sup>

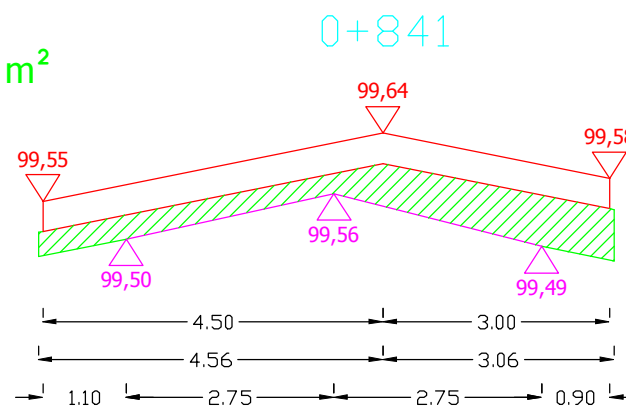

Pwyr.=0,3415 m<sup>2</sup>

Sporządził:

# PRZEKROJE POPRZECZNE DROGI WOJEWÓDZKIEJ NR 655 OD KM 101+819 DO KM 102+800

SKALA 1:10/100

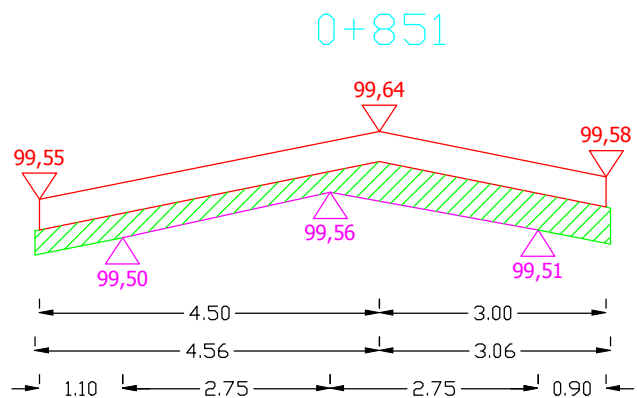

Pwyr.=0,2948 m<sup>2</sup>

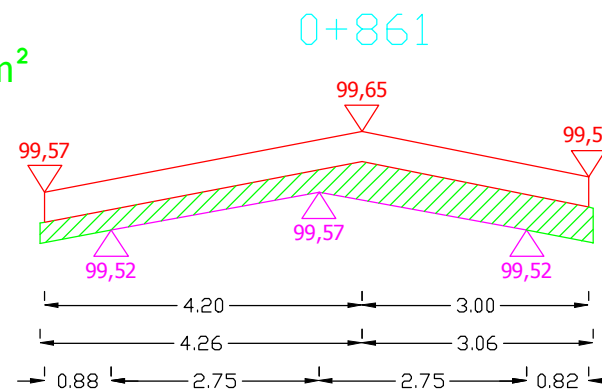

Pwyr.=0,2710 m<sup>2</sup>

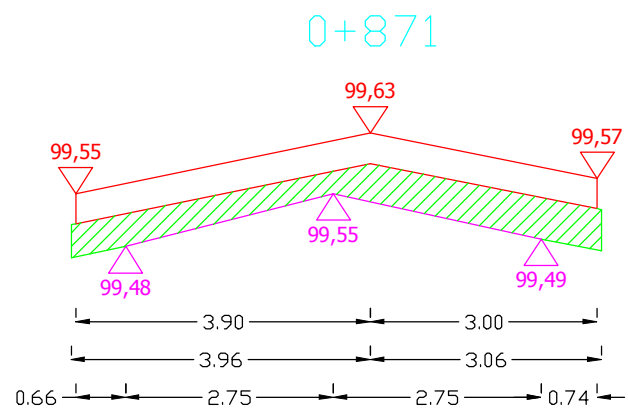

Pwyr.=0,3152 m<sup>2</sup>

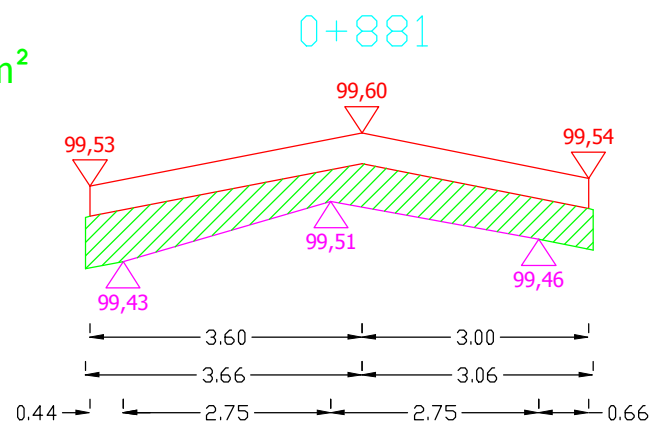

Pwyr.=0,3745 m<sup>2</sup>

Sporządził:

# PRZEKROJE POPRZECZNE DROGI WOJEWÓDZKIEJ NR 655 OD KM 101+819 DO KM 102+800

SKALA 1:10/100

0+891

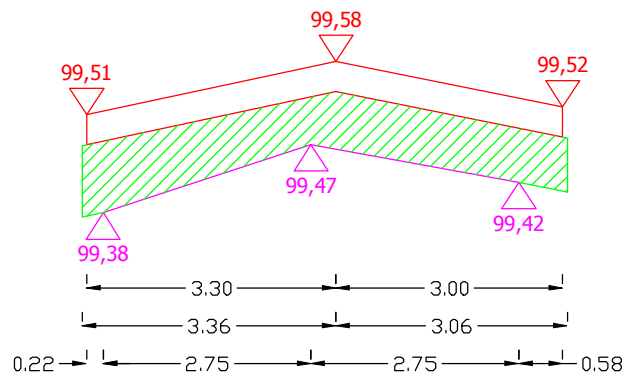

Pwyr.=0,4907 m<sup>2</sup>

0+901

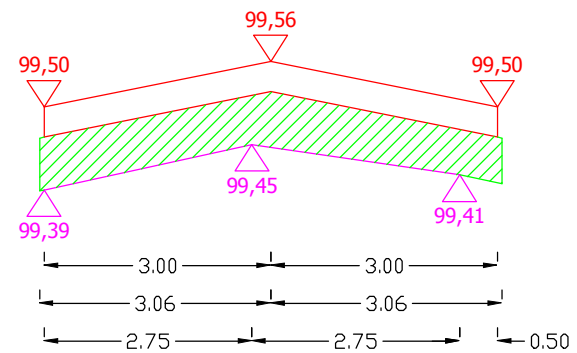

Pwyr.=0,4078 m<sup>2</sup>

0+911

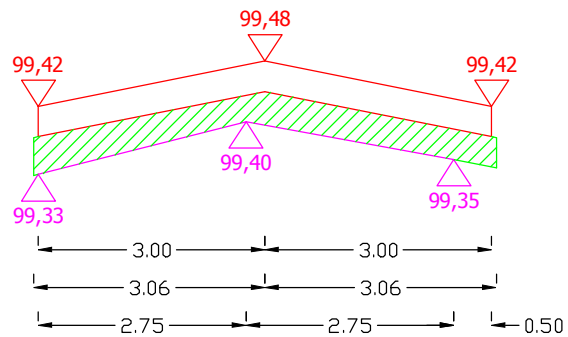

Pwyr.=0,2579 m<sup>2</sup>

0+921

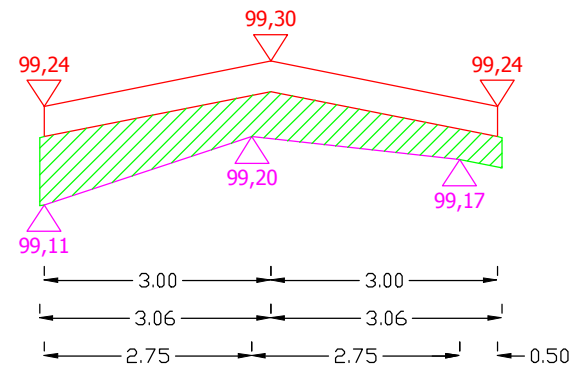

Pwyr.=0,3703 m<sup>2</sup>

Sporządził:



PRZEKROJE POPRZECZNE DROGI WOJEWÓDZKIEJ NR 655 OD KM 101+819 DO KM 102+800

SKALA 1:10/100

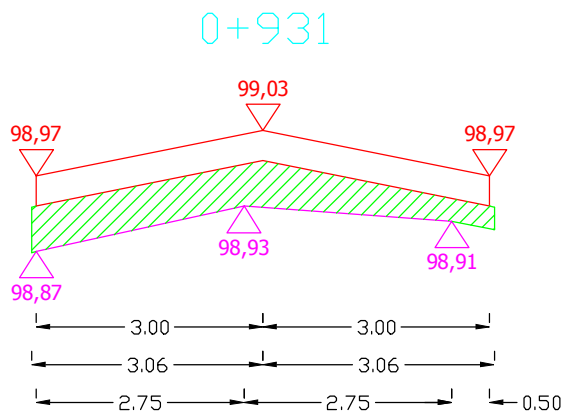

Pwyr.=0,3079 m<sup>2</sup>

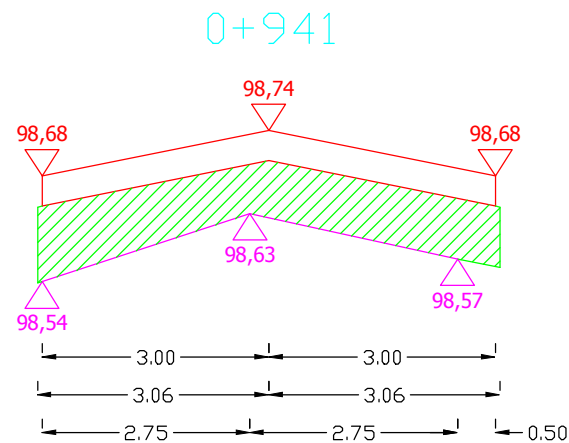

Pwyr.=0,4896 m<sup>2</sup>

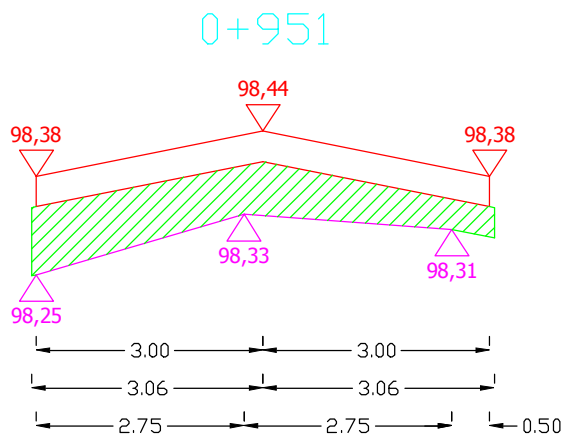

Pwyr.=0,3978 m<sup>2</sup>

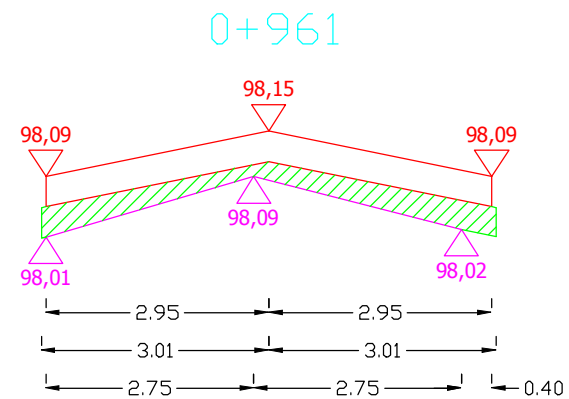

Pwyr.=0,1816 m<sup>2</sup>

Sporządził:

# PRZEKROJE POPRZECZNE DROGI WOJEWÓDZKIEJ NR 655 OD KM 101+819 DO KM 102+800

SKALA 1:10/100

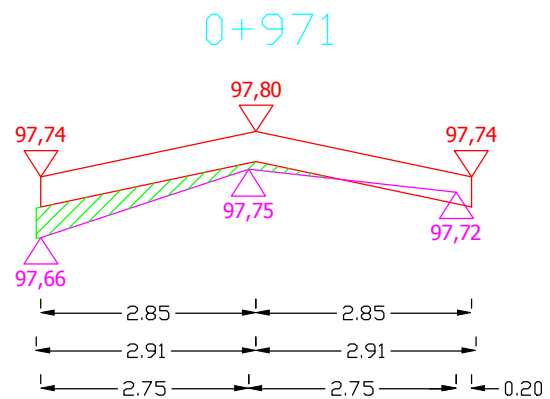

Pwyr.=0,0753 m<sup>2</sup>

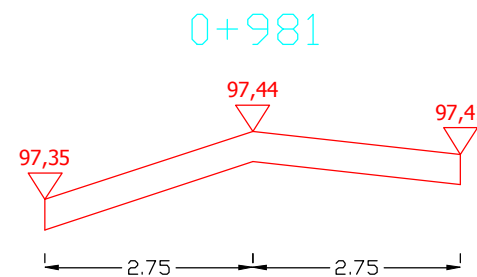

Pwyr.=0,0000 m<sup>2</sup>

Sporządził: