

PRZEKROJE POPRZECZNE DROGI WOJEWÓDZKIEJ NR 651 OD KM 59+676 DO KM 61+300

SKALA 1:10/100

0+000

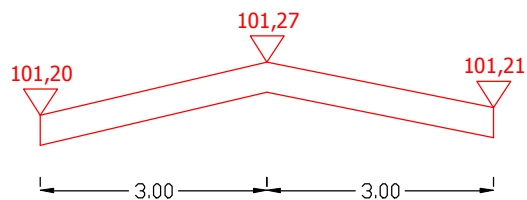

Pwyr.=0,0000 m²

0+010,50

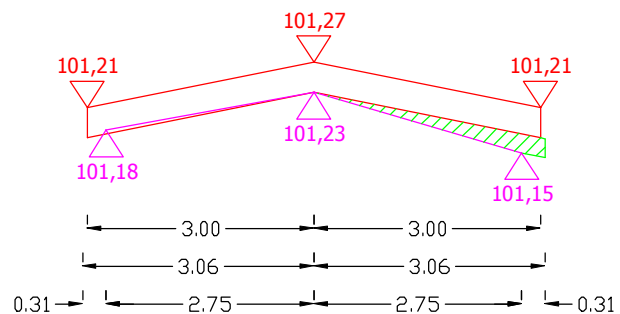

Pwyr.=0,0421 m²

0+014

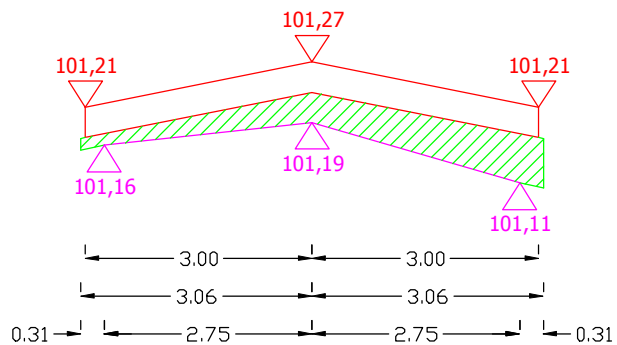

Pwyr.=0,2448 m²

0+024

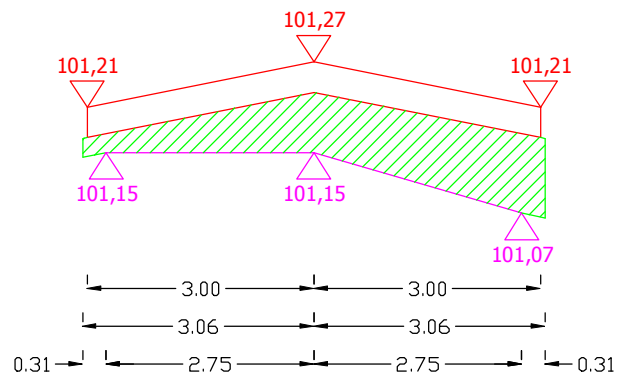

Pwyr.=0,4391 m²

Sporządził:

PRZEKROJE POPRZECZNE DROGI WOJEWÓDZKIEJ NR 651 OD KM 59+676 DO KM 61+300

SKALA 1:10/100

0+034

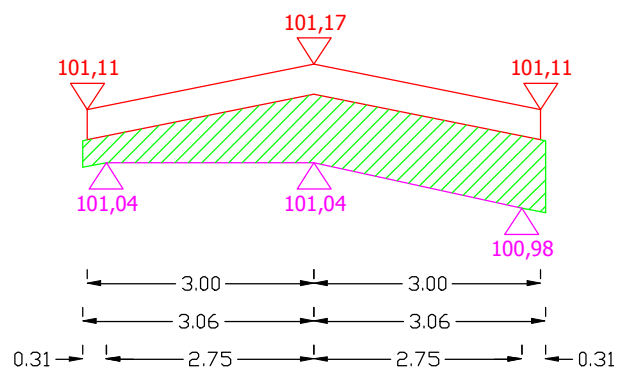

Pwyr.=0,4666 m²

0+044

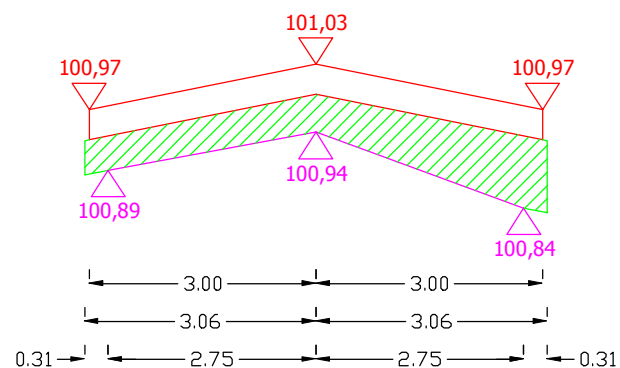

Pwyr.=0,3734 m²

0+054

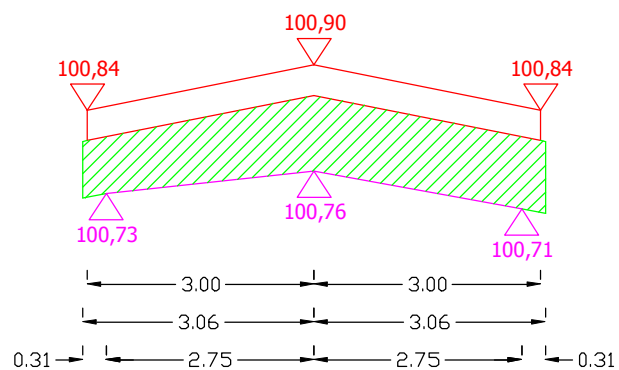

Pwyr.=0,5615 m²

0+064

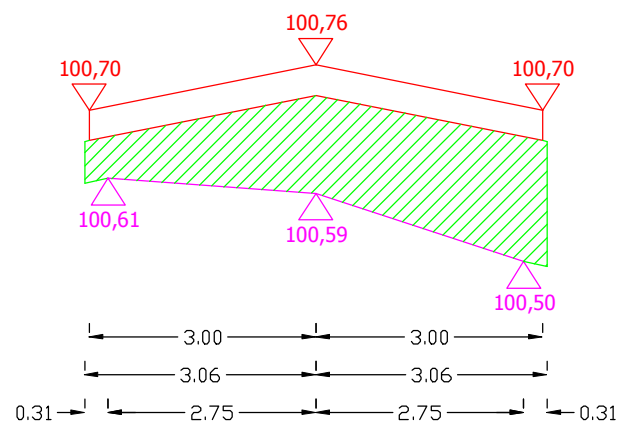

Pwyr.=0,7282 m²

Sporządził:

PRZEKROJE POPRZECZNE DROGI WOJEWÓDZKIEJ NR 651 OD KM 59+676 DO KM 61+300

SKALA 1:10/100

0+074

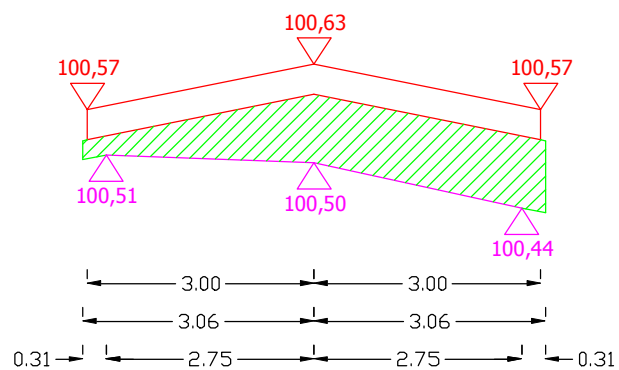

Pwyr.=0,4497 m²

0+084

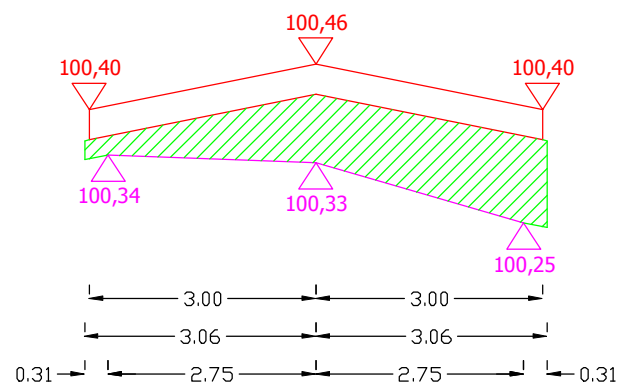

Pwyr.=0,4834 m²

0+094

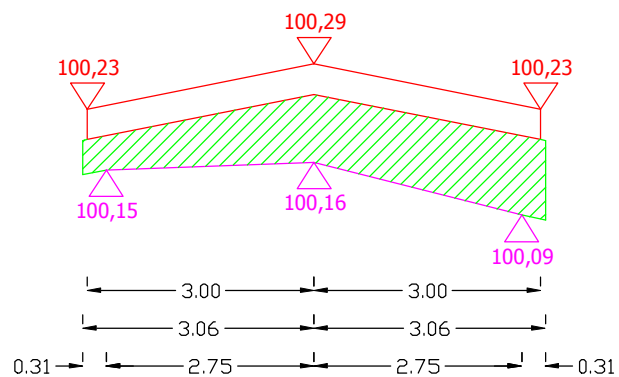

Pwyr.=0,5003 m²

0+104

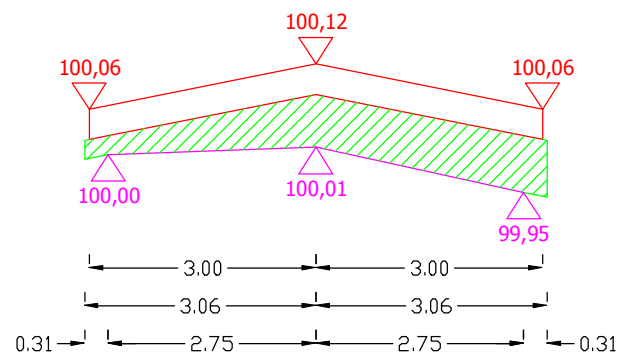

Pwyr.=0,3610 m²

Sporządził:

PRZEKROJE POPRZECZNE DROGI WOJEWÓDZKIEJ NR 651 OD KM 59+676 DO KM 61+300

SKALA 1:10/100

0+114

Pwyr.=0,4116 m²

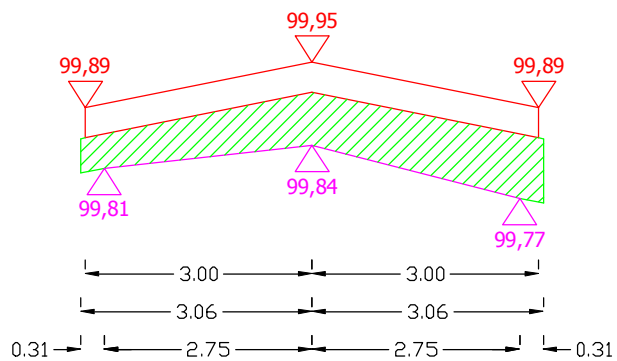

0+124

Pwyr.=0,3841 m²

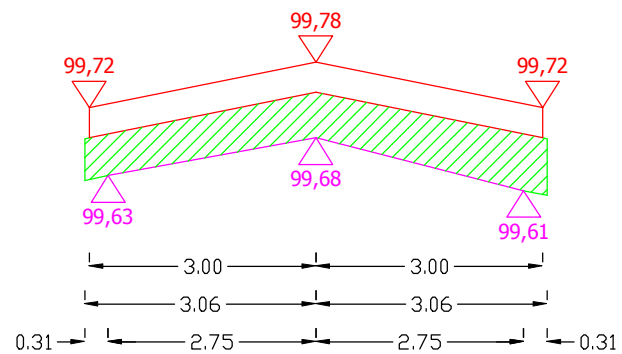

0+134

Pwyr.=0,3566 m²

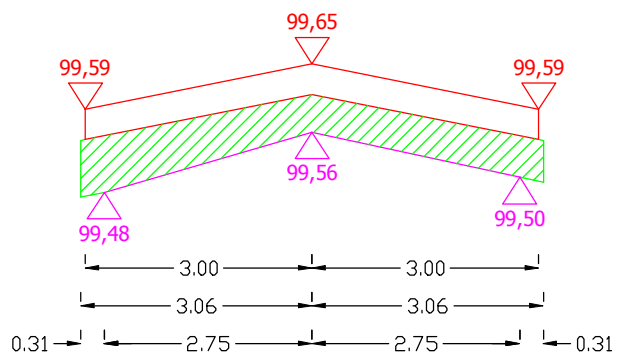

0+144

Pwyr.=0,3566 m²

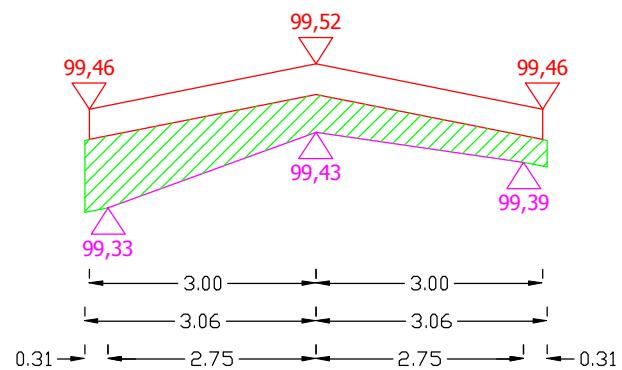

Sporządził:

PRZEKROJE POPRZECZNE DROGI WOJEWÓDZKIEJ NR 651 OD KM 59+676 DO KM 61+300

SKALA 1:10/100

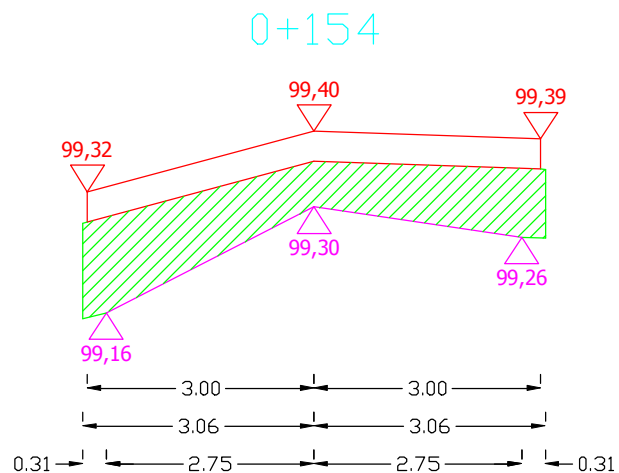

Pwyr.=0,5315 m²

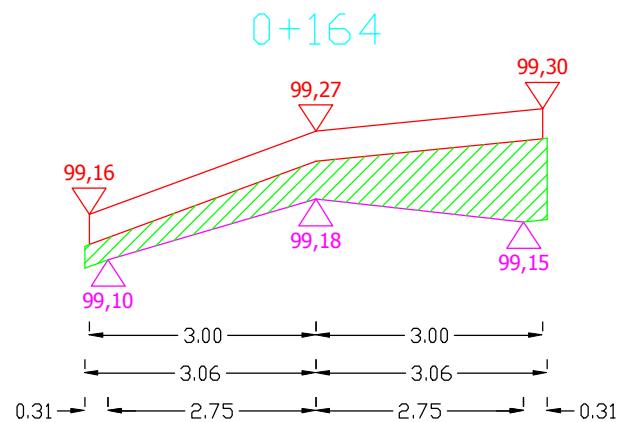

Pwyr.=0,3678 m²

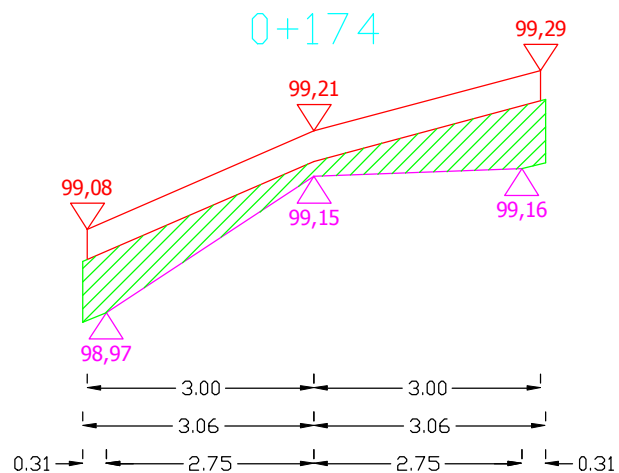

Pwyr.=0,3316 m²

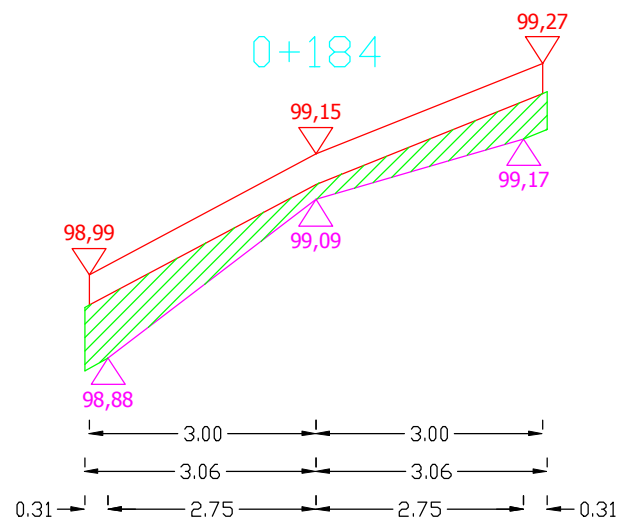

Pwyr.=0,2797 m²

Sporządził:

PRZEKROJE POPRZECZNE DROGI WOJEWÓDZKIEJ NR 651 OD KM 59+676 DO KM 61+300

SKALA 1:10/100

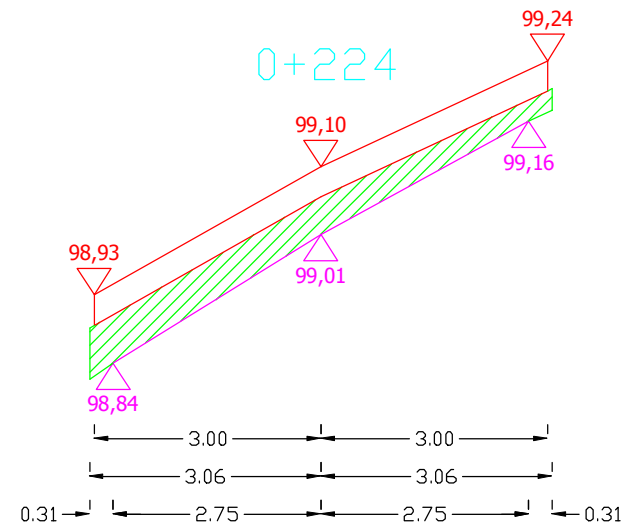
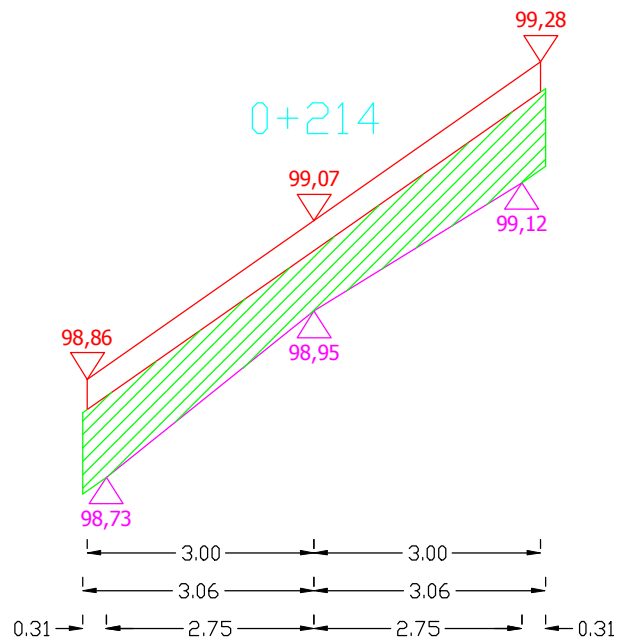
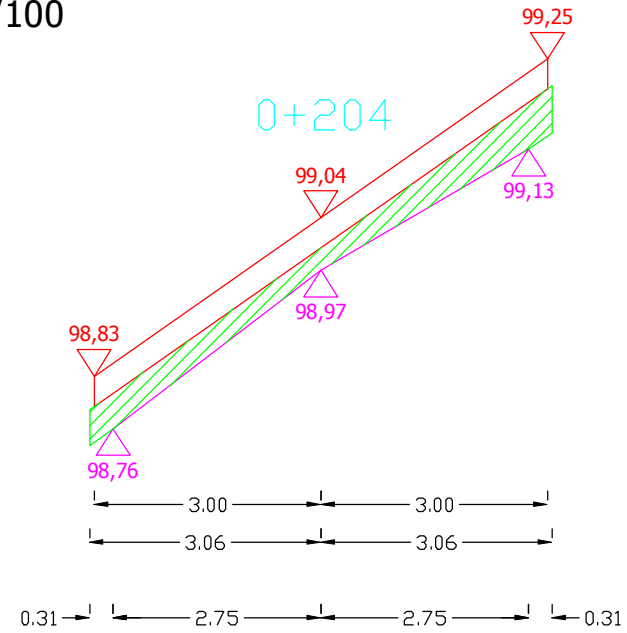
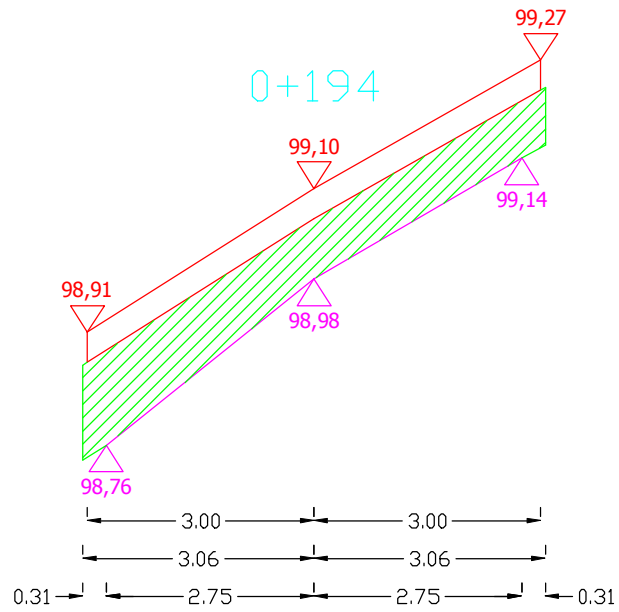

Sporządził:

PRZEKROJE POPRZECZNE DROGI WOJEWÓDZKIEJ NR 651 OD KM 59+676 DO KM 61+300

SKALA 1:10/100

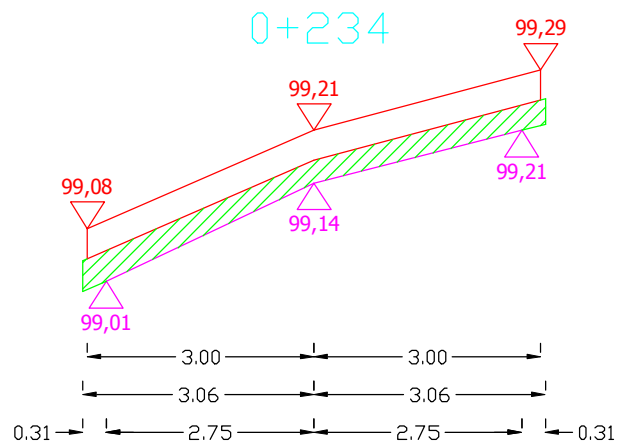

Pwyr.=0,2075 m²

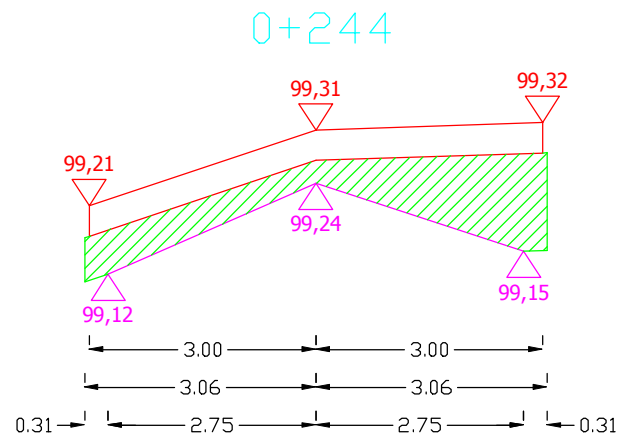

Pwyr.=0,3984 m²

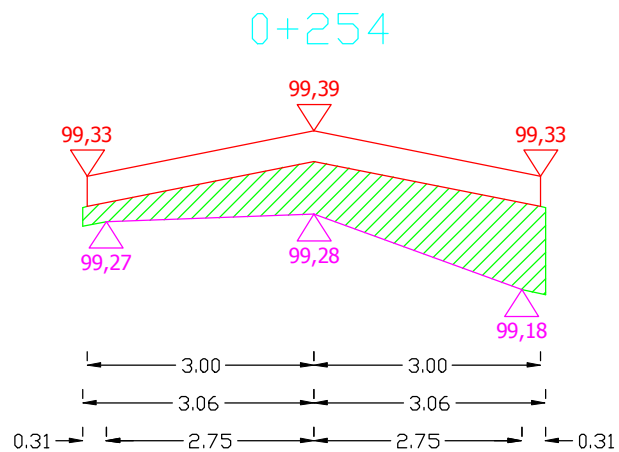

Pwyr.=0,4284 m²

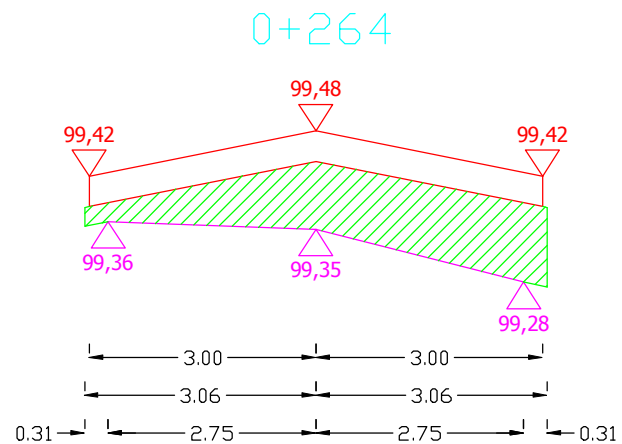

Pwyr.=0,4666 m²

Sporządził:

PRZEKROJE POPRZECZNE DROGI WOJEWÓDZKIEJ NR 651 OD KM 59+676 DO KM 61+300

SKALA 1:10/100

0+274

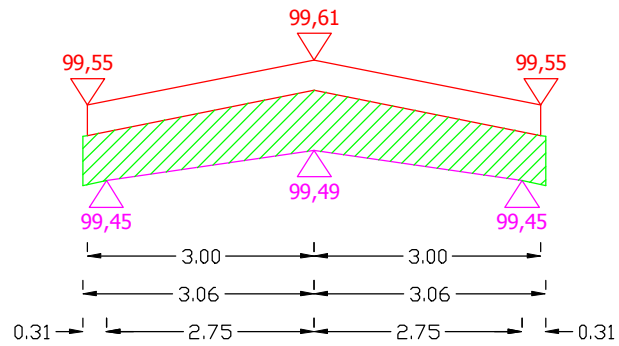

Pwyr.=0,4391 m²

0+284

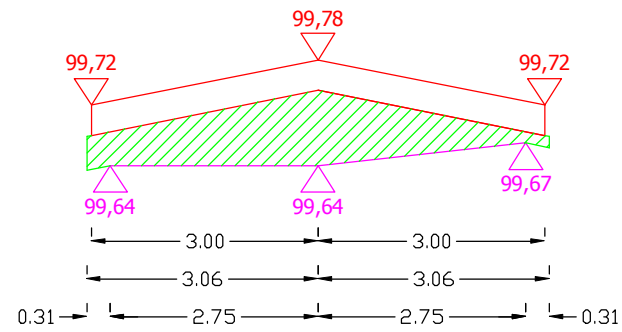

Pwyr.=0,3761 m²

0+294

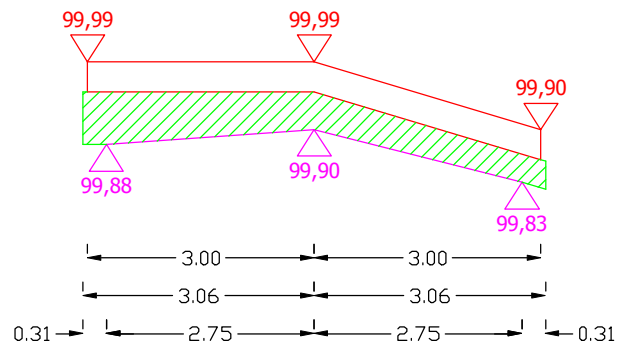

Pwyr.=0,3186 m²

0+304

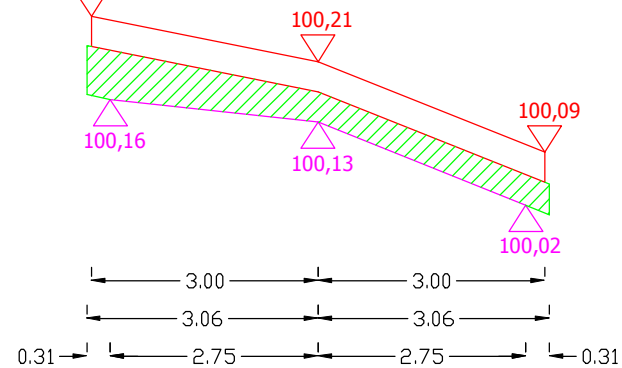

Pwyr.=0,2869 m²

Sporządził:

PRZEKROJE POPRZECZNE DROGI WOJEWÓDZKIEJ NR 651 OD KM 59+676 DO KM 61+300

SKALA 1:10/100

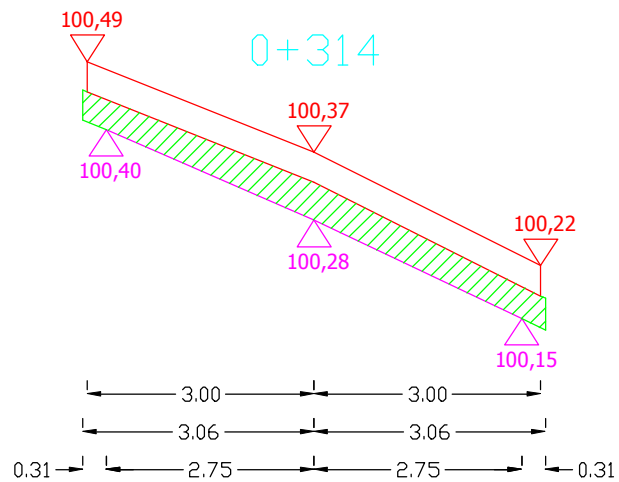

Pwyr.=0,2766 m²

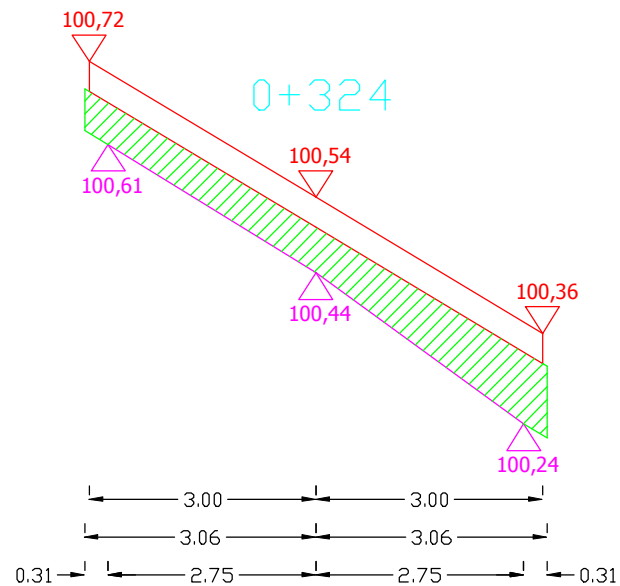

Pwyr.=0,4178 m²

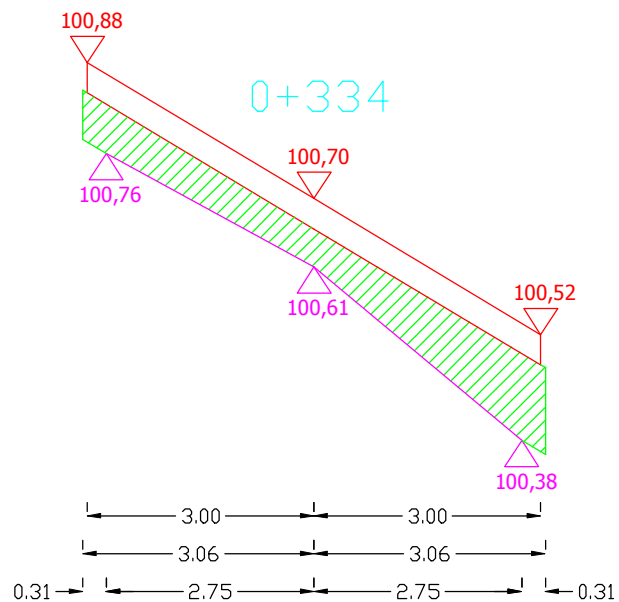

Pwyr.=0,4408 m²

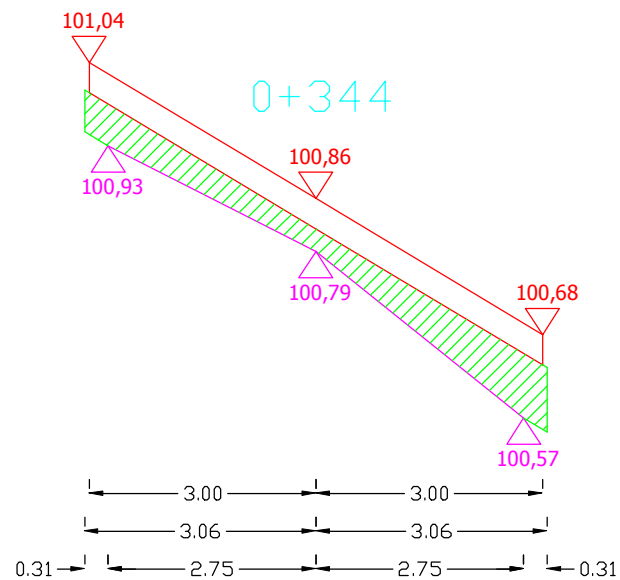

Pwyr.=0,3184 m²

Sporządził:

PRZEKROJE POPRZECZNE DROGI WOJEWÓDZKIEJ NR 651 OD KM 59+676 DO KM 61+300

SKALA 1:10/100

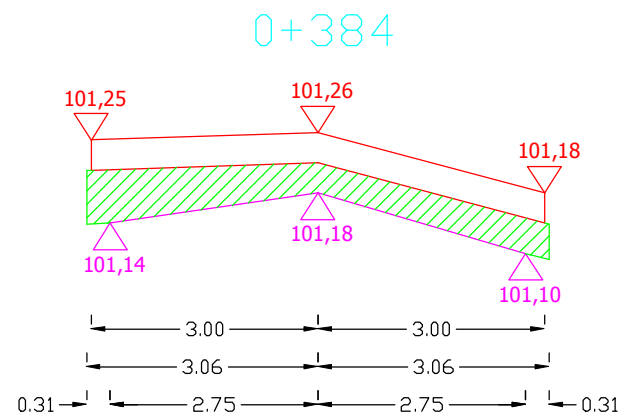
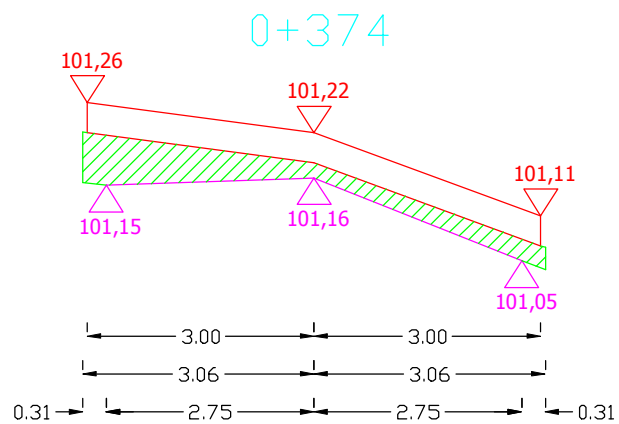
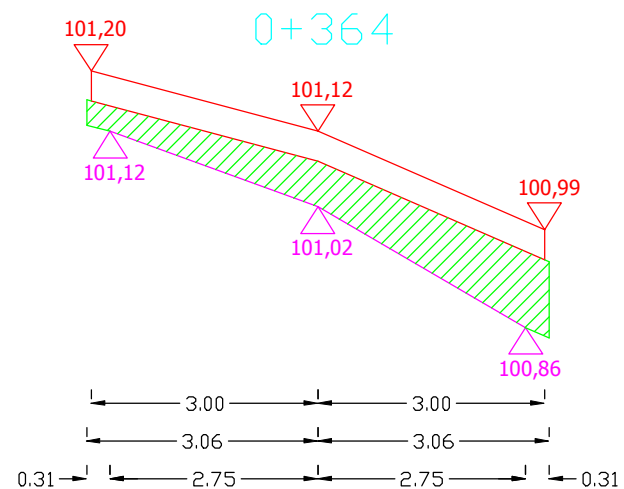
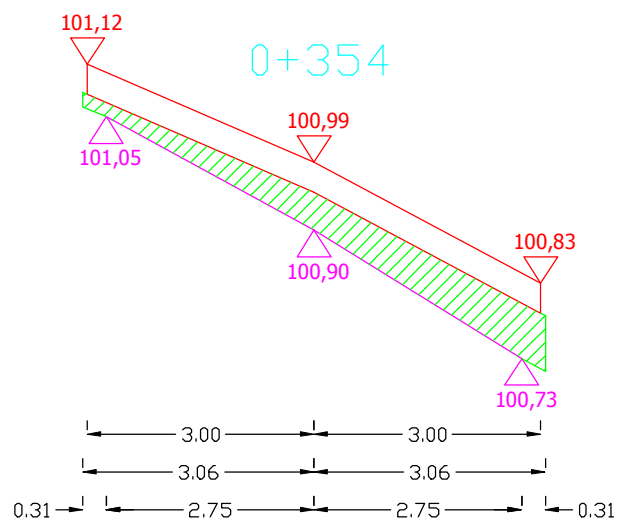

Sporządził:

PRZEKROJE POPRZECZNE DROGI WOJEWÓDZKIEJ NR 651 OD KM 59+676 DO KM 61+300

SKALA 1:10/100

0+394

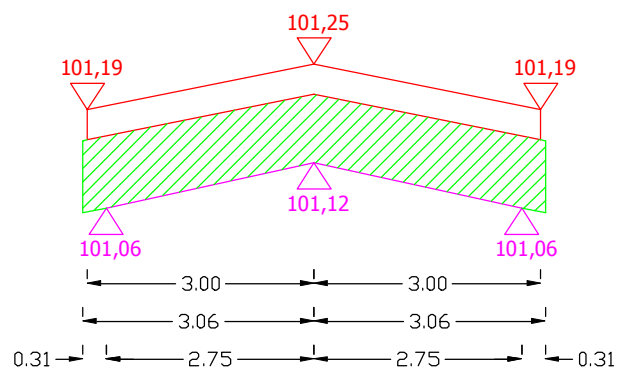

Pwyr.=0,5677 m²

0+404

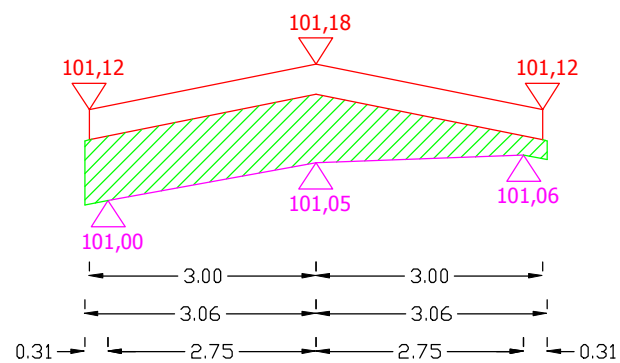

Pwyr.=0,4329 m²

0+414

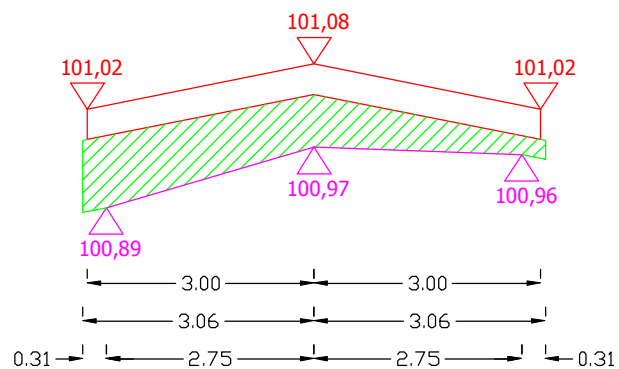

Pwyr.=0,3947 m²

0+424

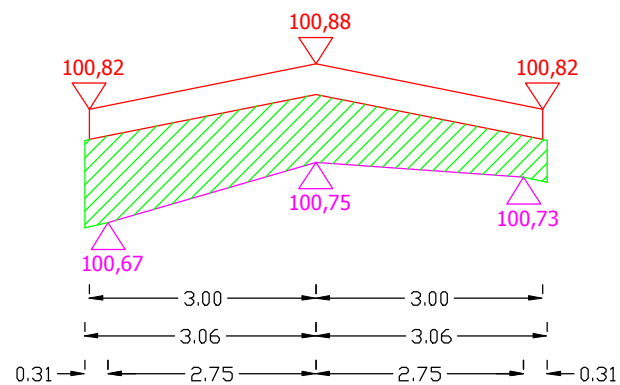

Pwyr.=0,5340 m²

Sporządził:

PRZEKROJE POPRZECZNE DROGI WOJEWÓDZKIEJ NR 651 OD KM 59+676 DO KM 61+300

SKALA 1:10/100

0+434

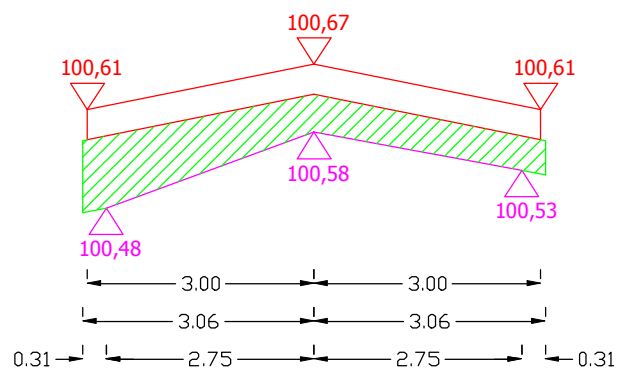

Pwyr.=0,3734 m²

0+444

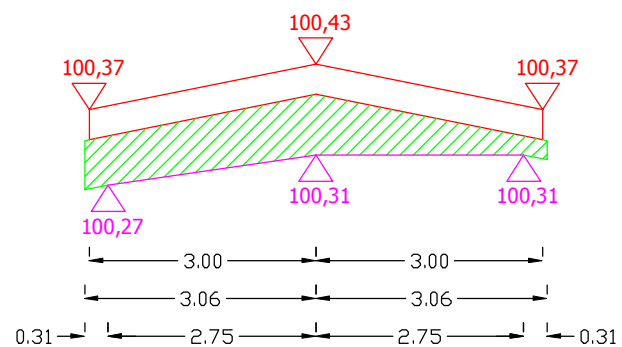

Pwyr.=0,3717 m²

0+454

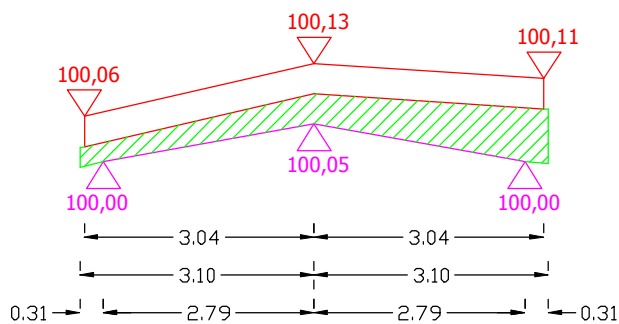

Pwyr.=0,2775 m²

0+464

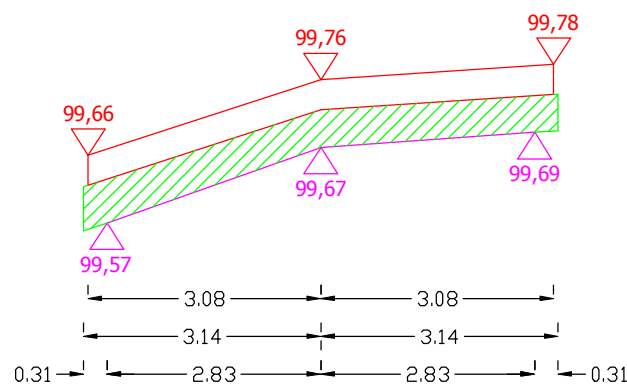

Pwyr.=0,3252 m²

Sporządził:

PRZEKROJE POPRZECZNE DROGI WOJEWÓDZKIEJ NR 651 OD KM 59+676 DO KM 61+300

SKALA 1:10/100

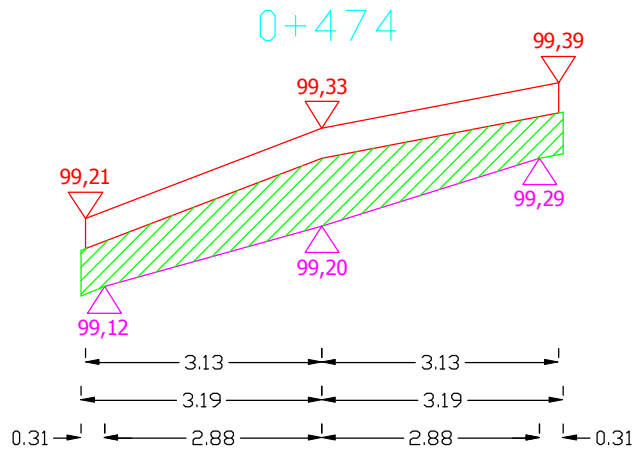

Pwyr.=0,4601 m²

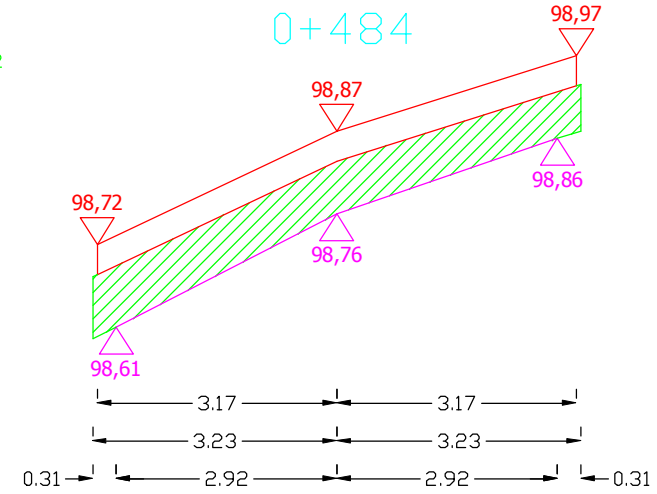

Pwyr.=0,4592 m²

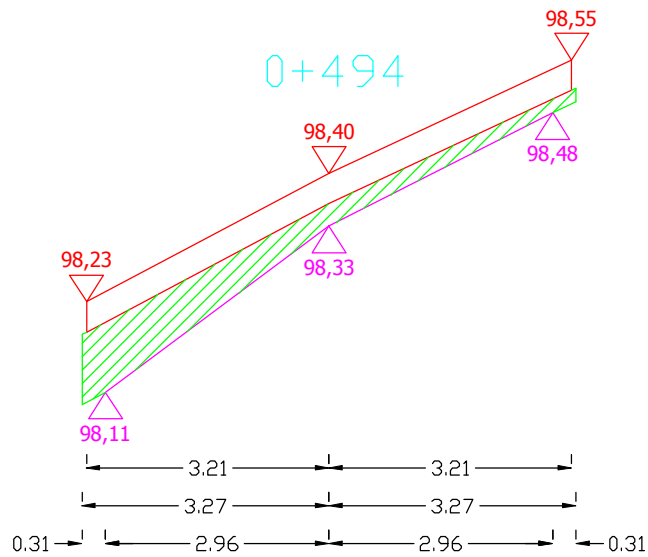

Pwyr.=0,2885 m²

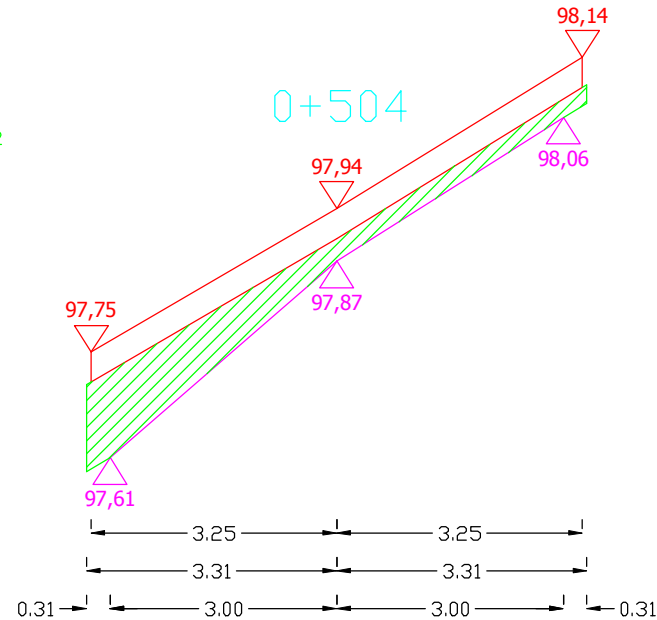

Pwyr.=0,3420 m²

Sporządził:

PRZEKROJE POPRZECZNE DROGI WOJEWÓDZKIEJ NR 651 OD KM 59+676 DO KM 61+300

SKALA 1:10/100

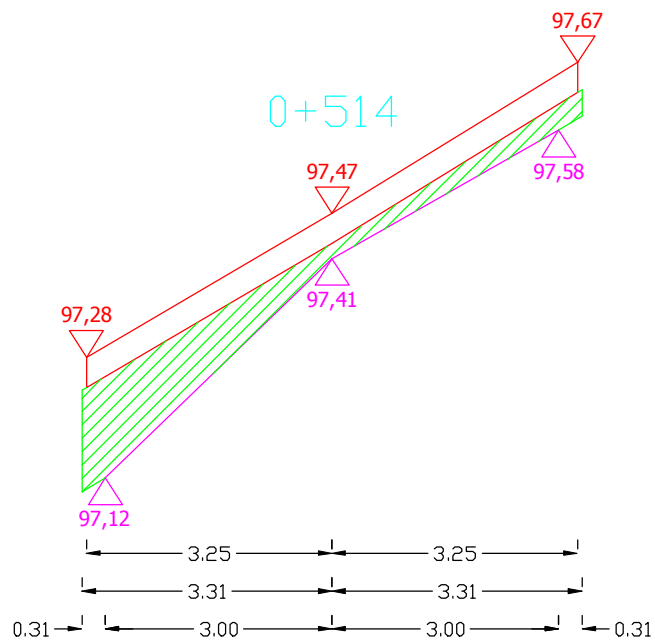

Pwyr.=0,3663 m²

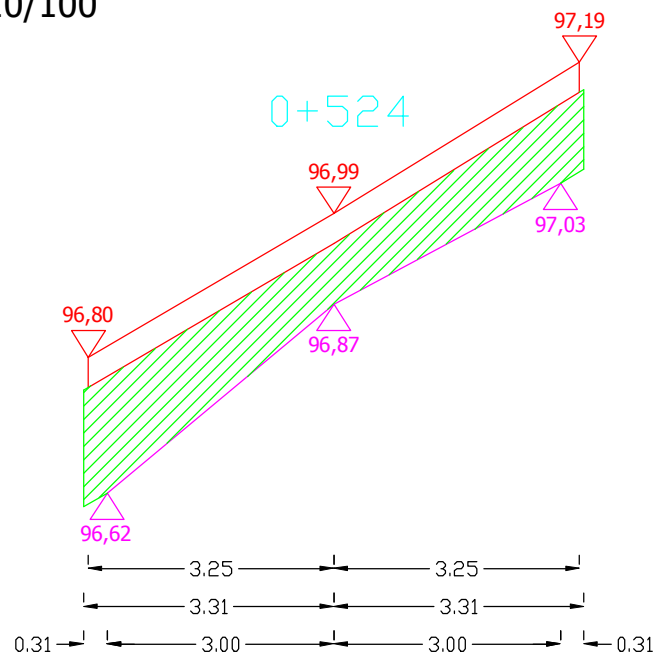

Pwyr.=0,7092 m²

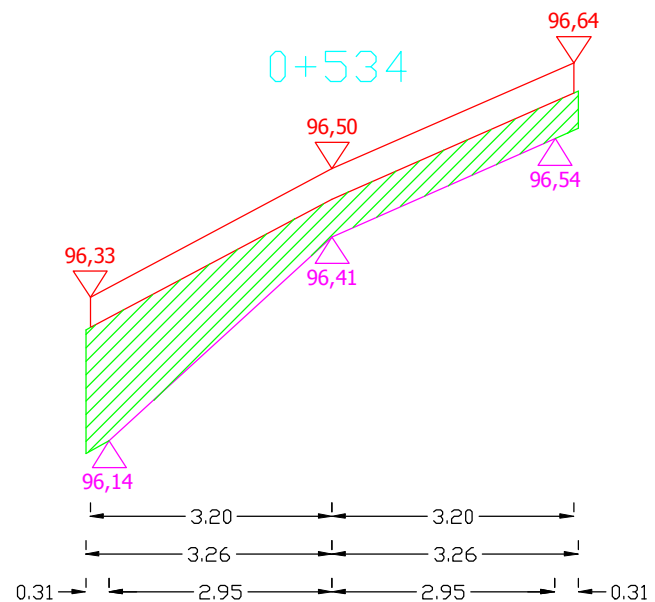

Pwyr.=0,5265 m²

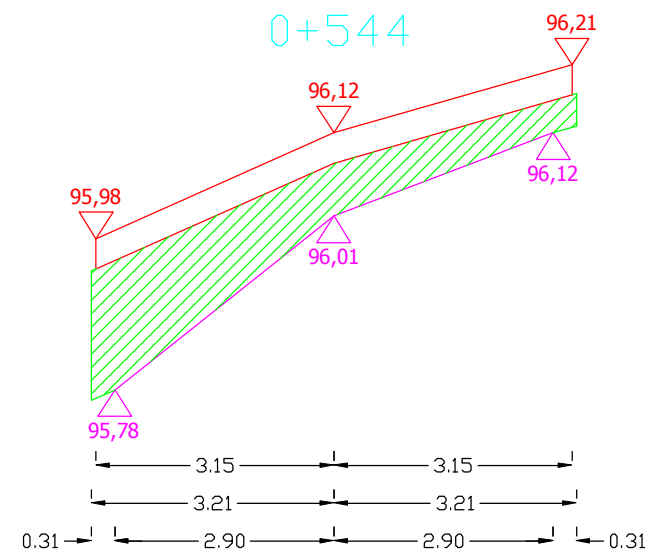

Pwyr.=0,5796 m²

Sporządził:

PRZEKROJE POPRZECZNE DROGI WOJEWÓDZKIEJ NR 651 OD KM 59+676 DO KM 61+300

SKALA 1:10/100

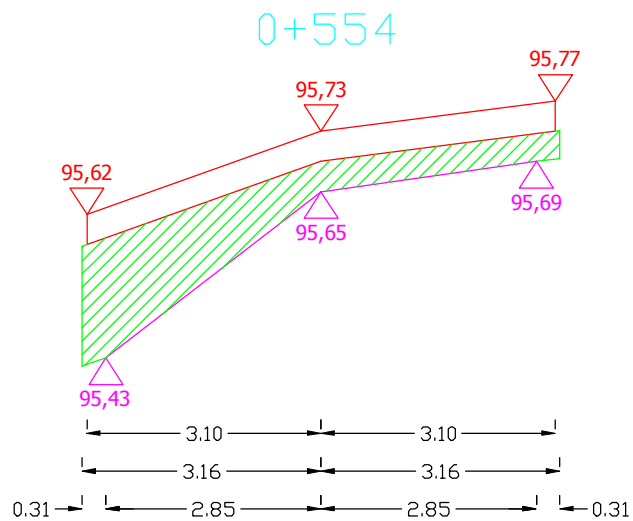

Pwyr.=0,4534 m²

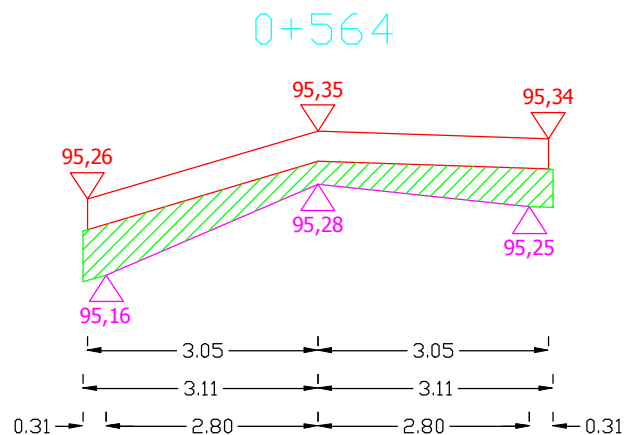

Pwyr.=0,2861 m²

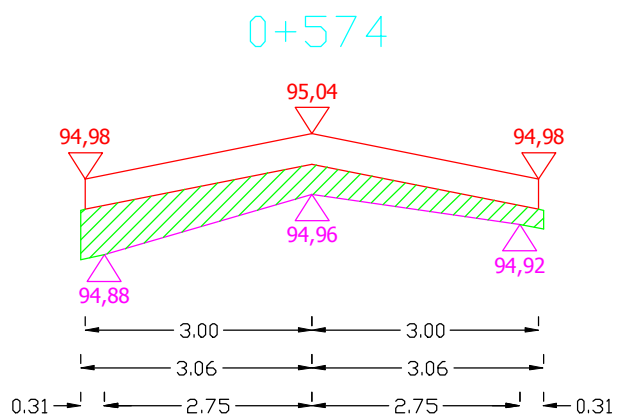

Pwyr.=0,2617 m²

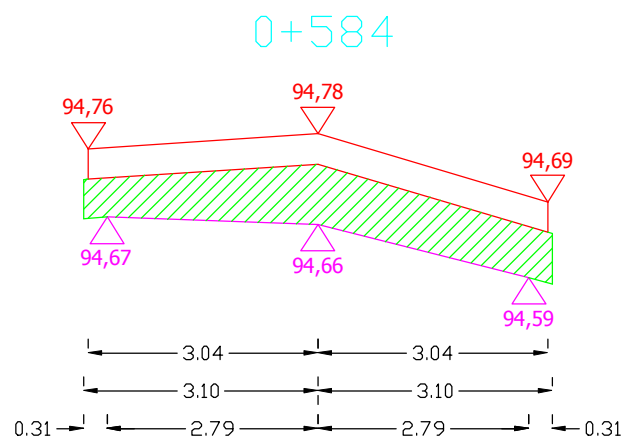

Pwyr.=0,4262 m²

Sporządził:

PRZEKROJE POPRZECZNE DROGI WOJEWÓDZKIEJ NR 651 OD KM 59+676 DO KM 61+300

SKALA 1:10/100

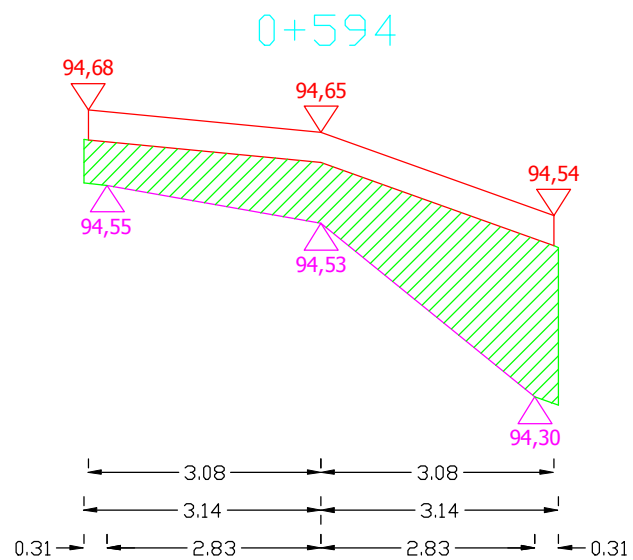

Pwyr.=0,6872 m²

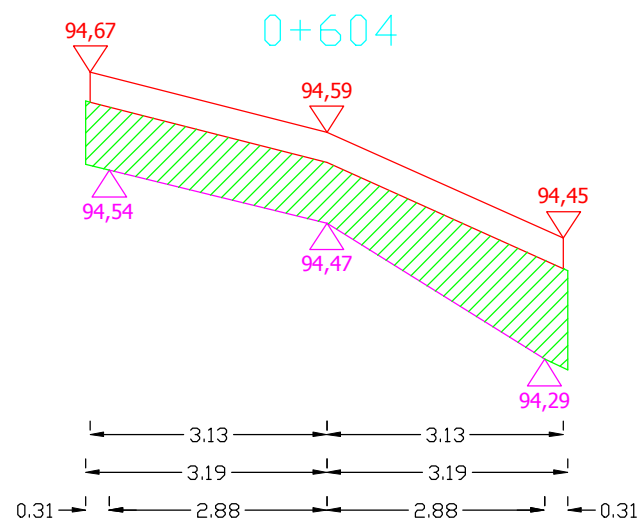

Pwyr.=0,6063 m²

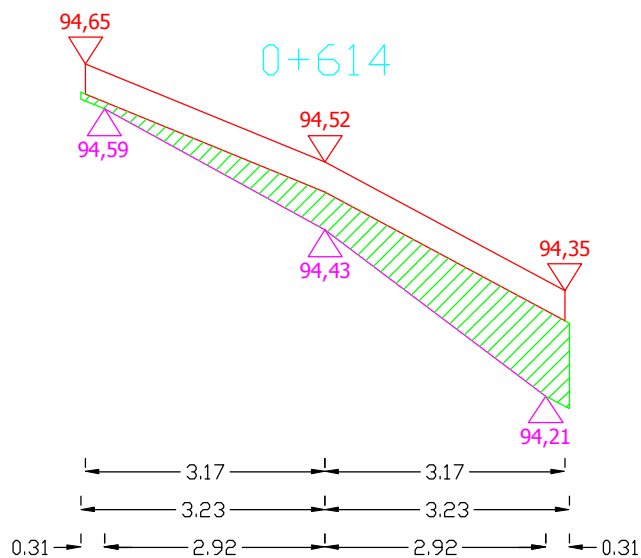

Pwyr.=0,3640 m²

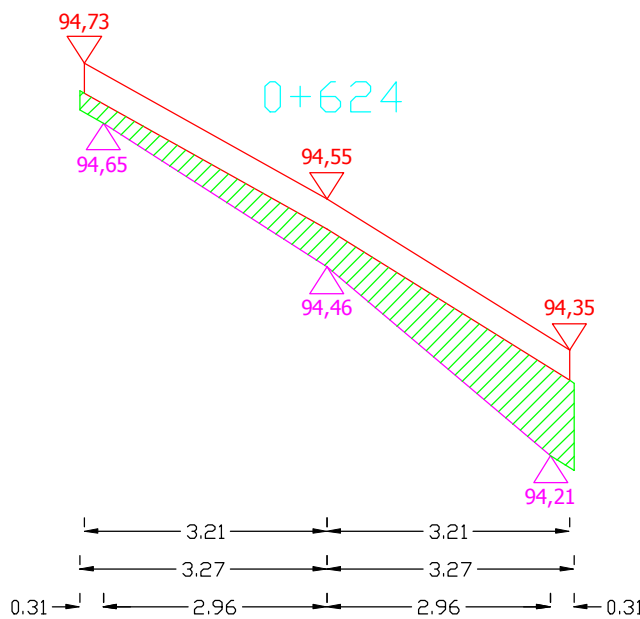

Pwyr.=0,4014 m²

Sporządził:

PRZEKROJE POPRZECZNE DROGI WOJEWÓDZKIEJ NR 651 OD KM 59+676 DO KM 61+300

SKALA 1:10/100

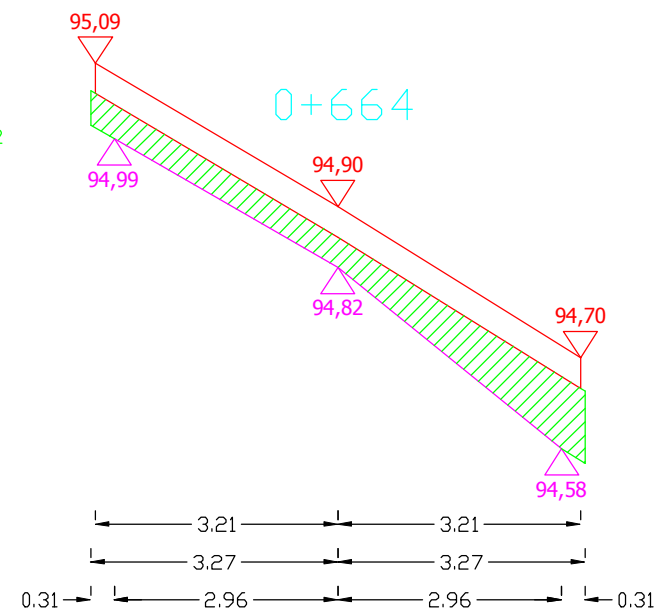
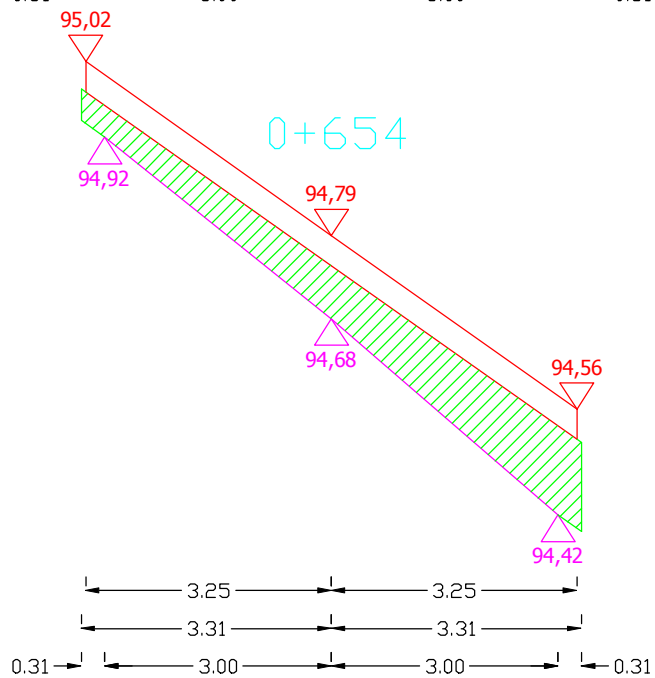
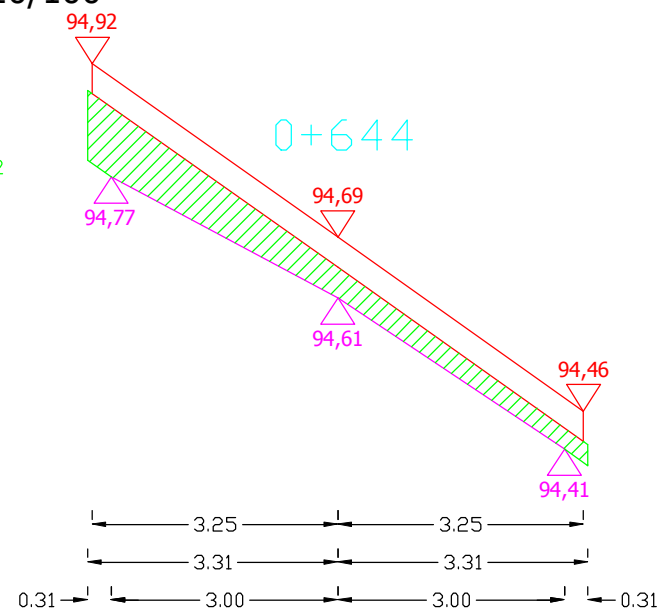
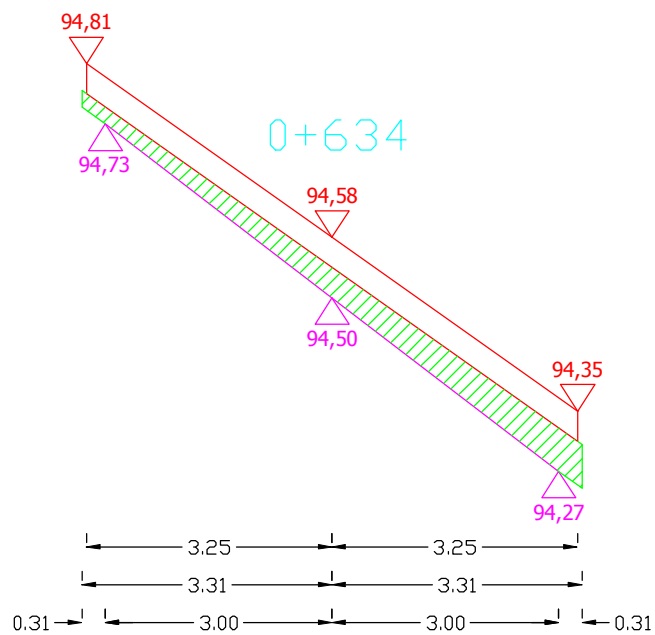

Sporządził:

PRZEKROJE POPRZECZNE DROGI WOJEWÓDZKIEJ NR 651 OD KM 59+676 DO KM 61+300

SKALA 1:10/100

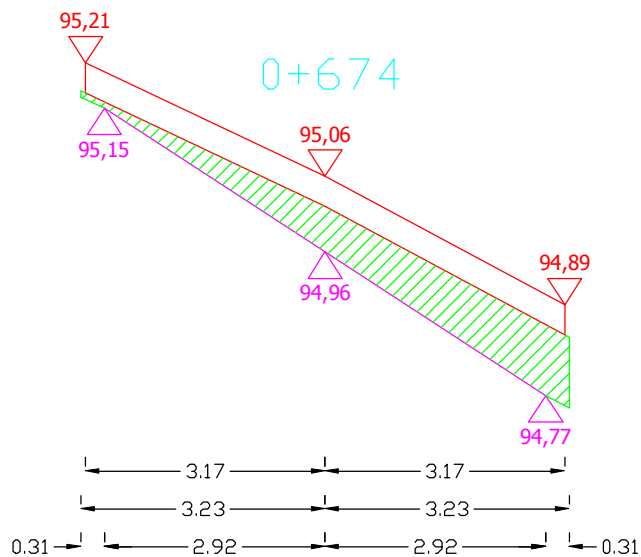

Pwyr.=0,3550 m²

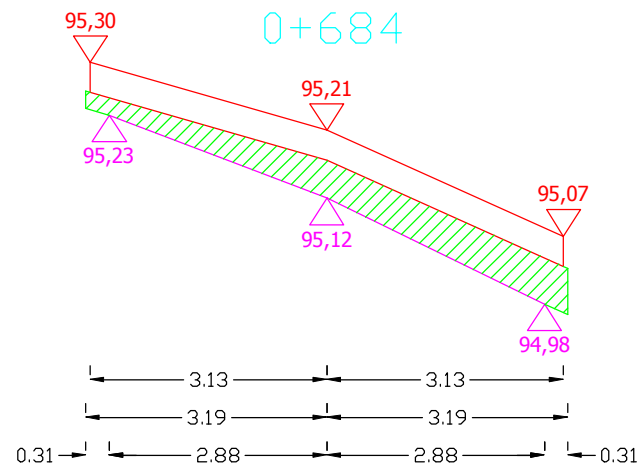

Pwyr.=0,2910 m²

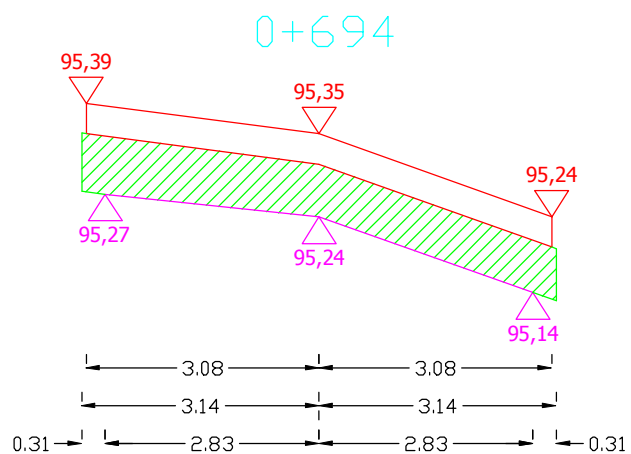

Pwyr.=0,4494 m²

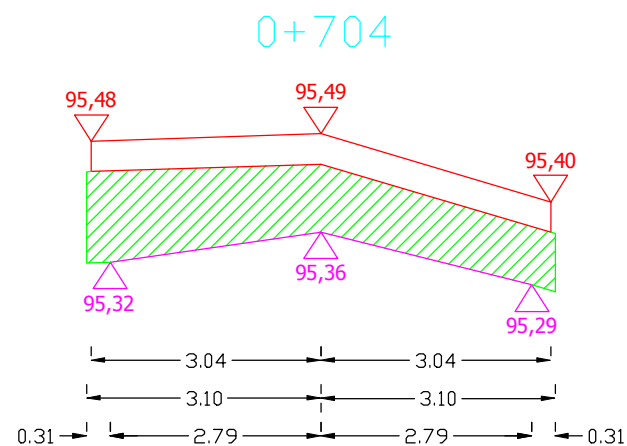

Pwyr.=0,5891 m²

Sporządził:

PRZEKROJE POPRZECZNE DROGI WOJEWÓDZKIEJ NR 651 OD KM 59+676 DO KM 61+300

SKALA 1:10/100

0+714

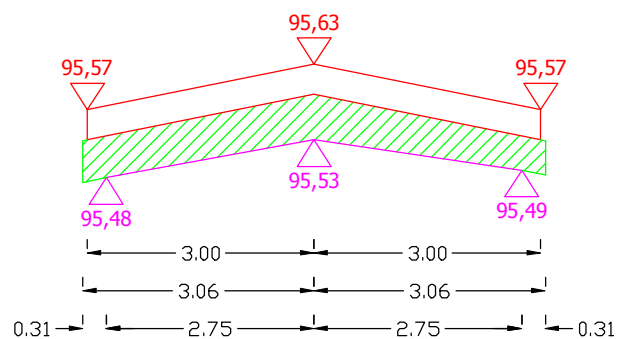

Pwyr.=0,3335 m²

0+724

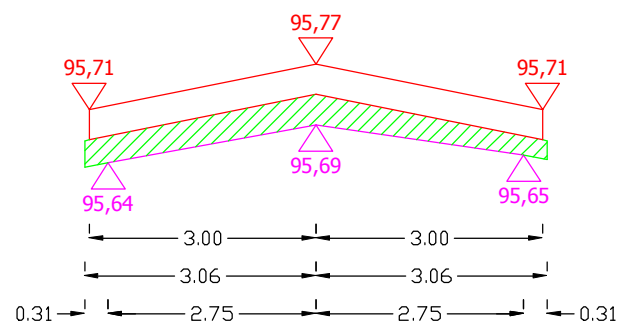

Pwyr.=0,2111 m²

0+734

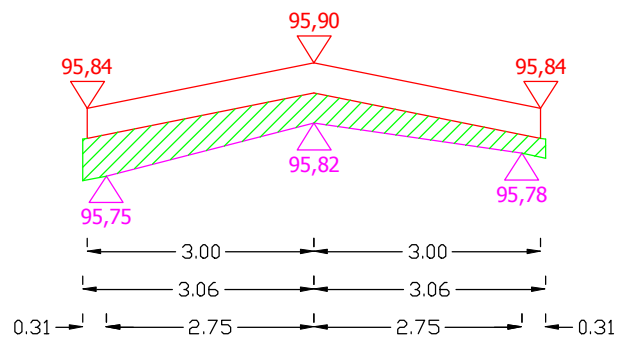

Pwyr.=0,2448 m²

0+744

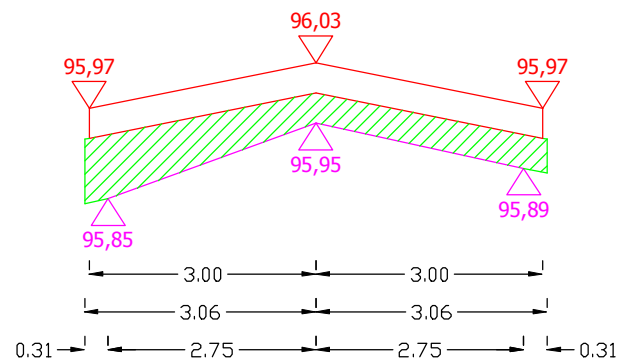

Pwyr.=0,3291 m²

Sporządził:

PRZEKROJE POPRZECZNE DROGI WOJEWÓDZKIEJ NR 651 OD KM 59+676 DO KM 61+300

SKALA 1:10/100

0+754

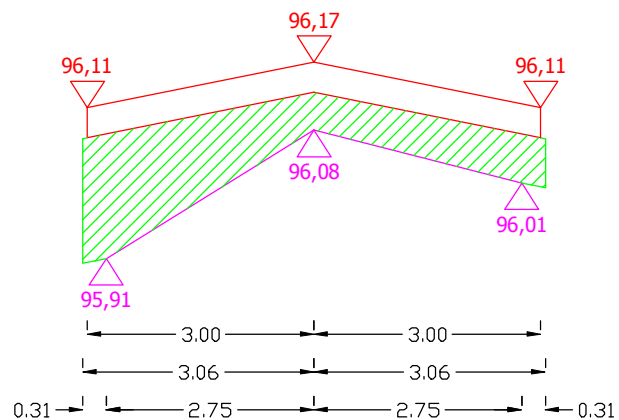

$P_{wyr.}=0,5251 \text{ m}^2$

0+764

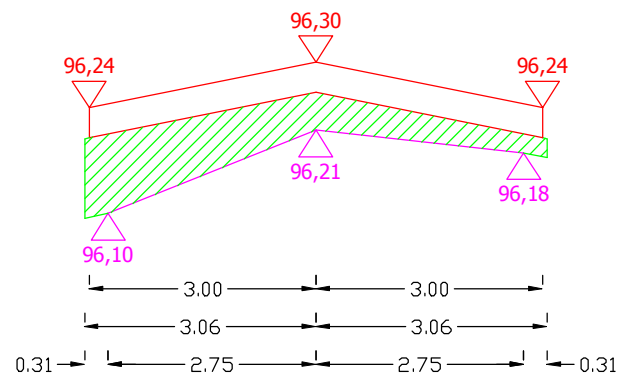

$P_{wyr.}=0,3566 \text{ m}^2$

0+774

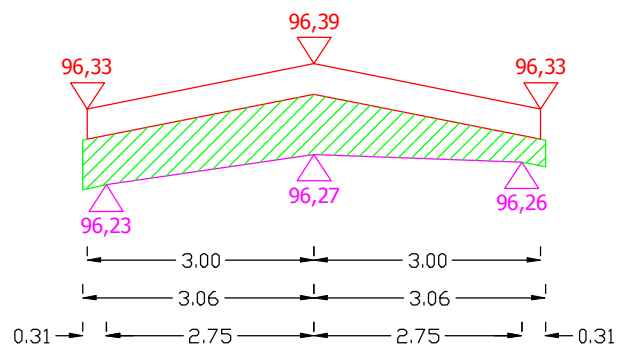

$P_{wyr.}=0,3885 \text{ m}^2$

0+784

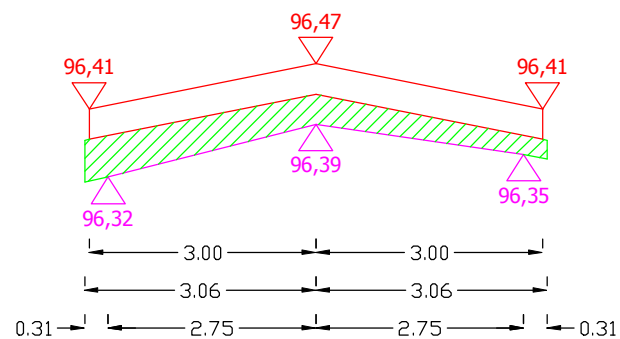

$P_{wyr.}=0,2448 \text{ m}^2$

Sporządził:

PRZEKROJE POPRZECZNE DROGI WOJEWÓDZKIEJ NR 651 OD KM 59+676 DO KM 61+300

SKALA 1:10/100

0+794

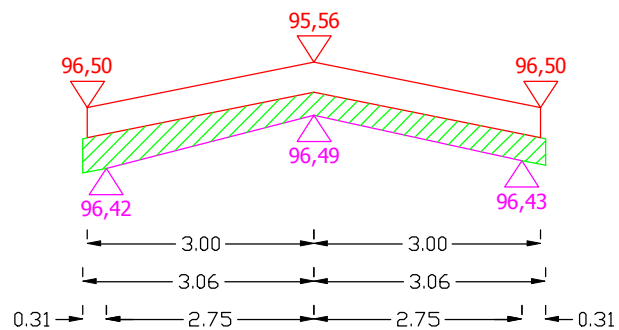

$P_{wyr.} = 0,2173 \text{ m}^2$

0+804

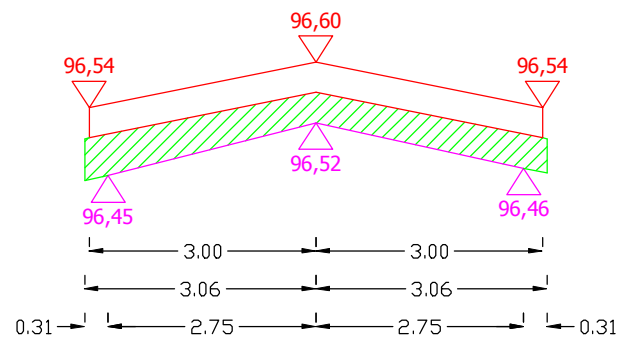

$P_{wyr.} = 0,2785 \text{ m}^2$

0+814

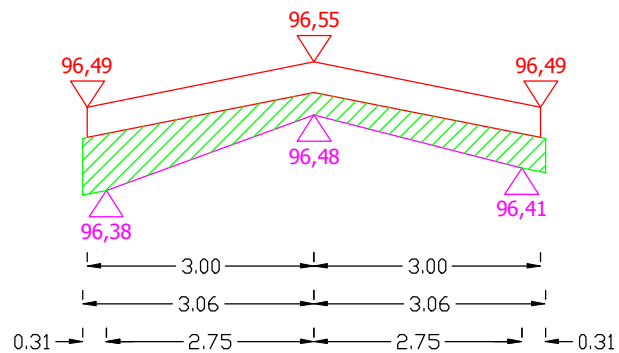

$P_{wyr.} = 0,2847 \text{ m}^2$

0+824

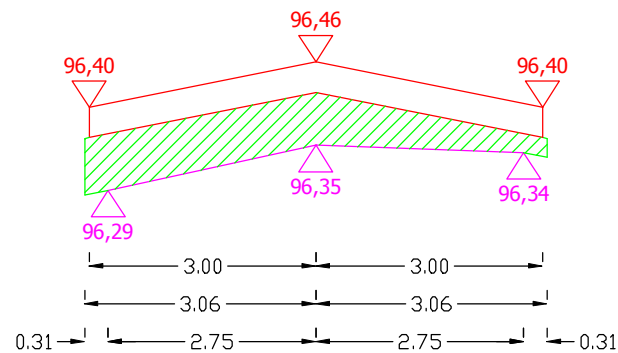

$P_{wyr.} = 0,3610 \text{ m}^2$

Sporządził:

PRZEKROJE POPRZECZNE DROGI WOJEWÓDZKIEJ NR 651 OD KM 59+676 DO KM 61+300

SKALA 1:10/100

0+834

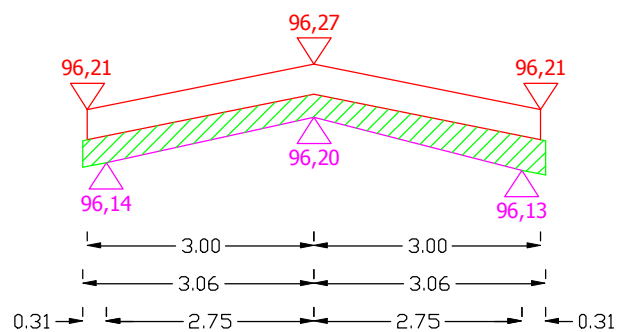

Pwyr.=0,2173 m²

0+844

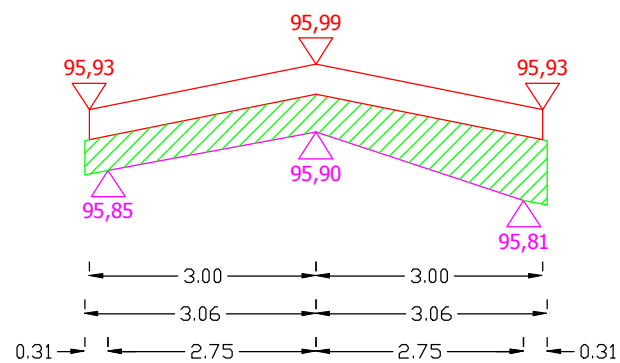

Pwyr.=0,3566 m²

0+854

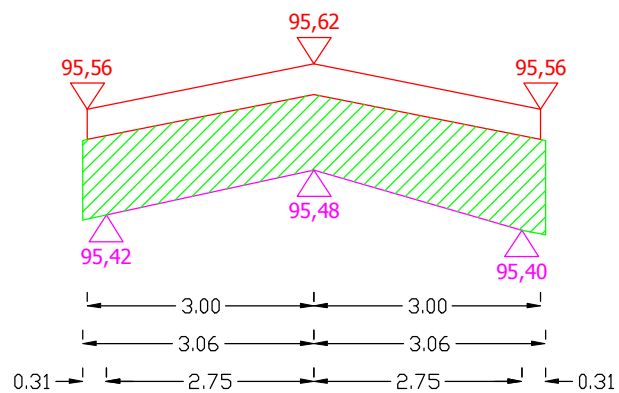

Pwyr.=0,6626 m²

0+864

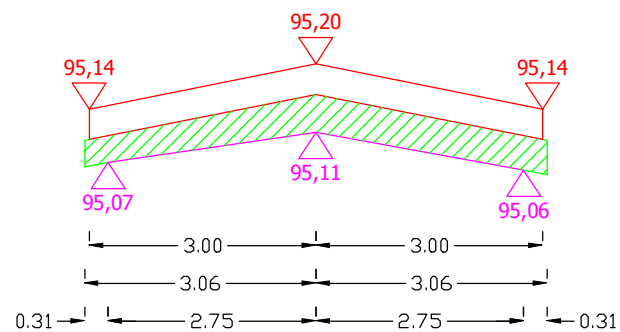

Pwyr.=0,2723 m²

Sporządził:

PRZEKROJE POPRZECZNE DROGI WOJEWÓDZKIEJ NR 651 OD KM 59+676 DO KM 61+300

SKALA 1:10/100

0+874

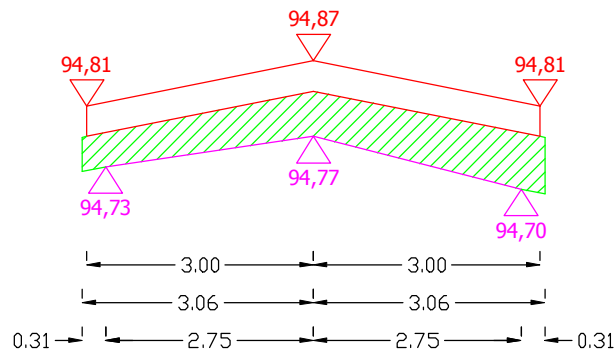

Pwyr.=0,3672 m²

0+884

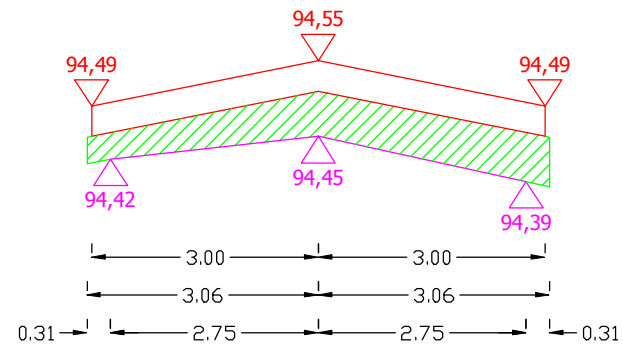

Pwyr.=0,3335 m²

0+894

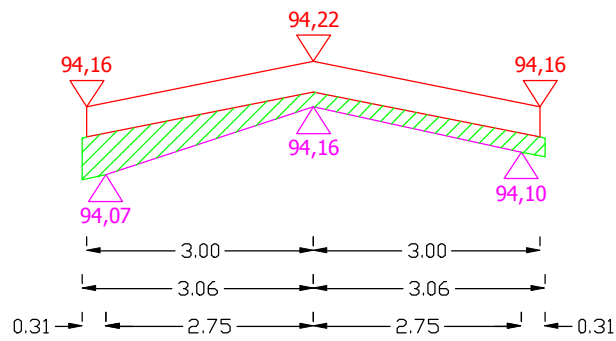

Pwyr.=0,1898 m²

0+904

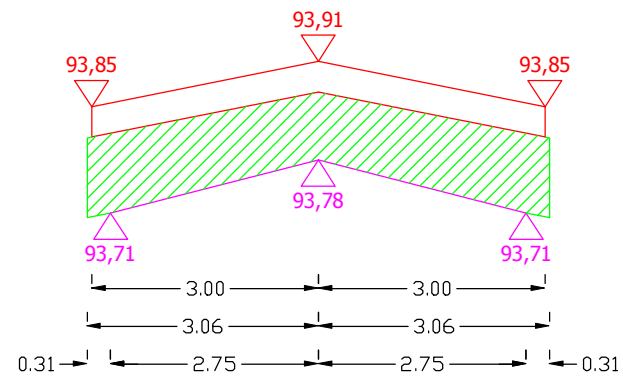

Pwyr.=0,6014 m²

Sporządził:

PRZEKROJE POPRZECZNE DROGI WOJEWÓDZKIEJ NR 651 OD KM 59+676 DO KM 61+300

SKALA 1:10/100

0+914

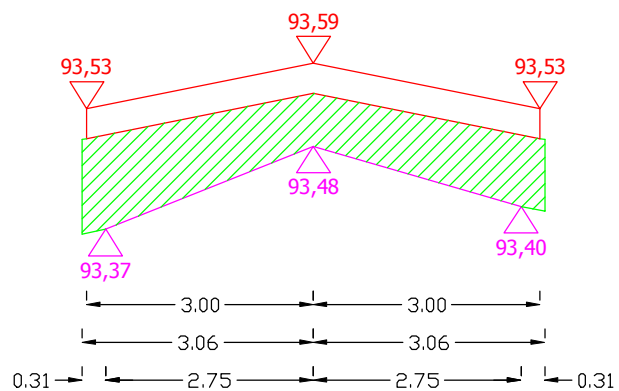

Pwyr.=0,5632 m²

0+924

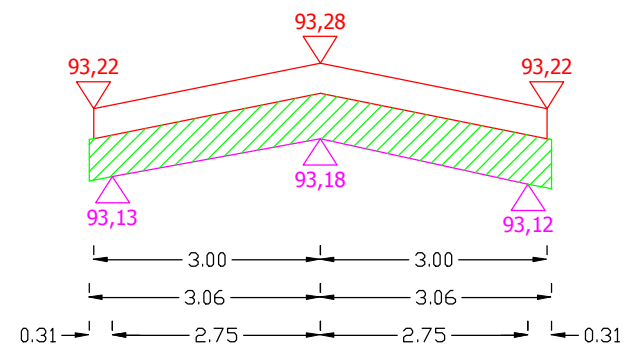

Pwyr.=0,3677 m²

0+934

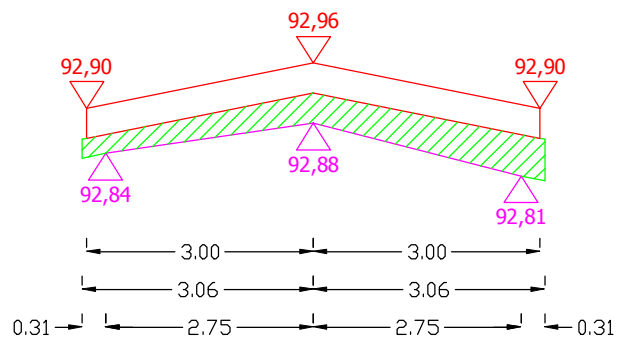

Pwyr.=0,2448 m²

0+944

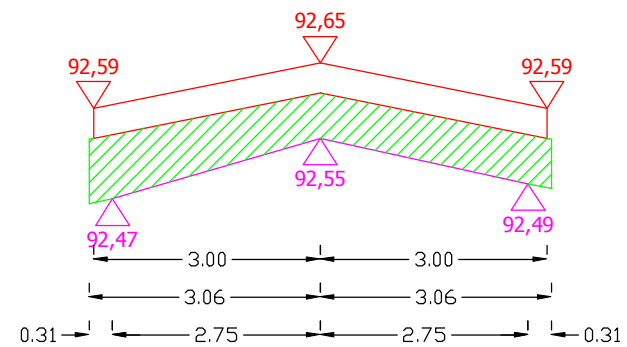

Pwyr.=0,4178 m²

Sporządził:

PRZEKROJE POPRZECZNE DROGI WOJEWÓDZKIEJ NR 651 OD KM 59+676 DO KM 61+300

SKALA 1:10/100

0+954

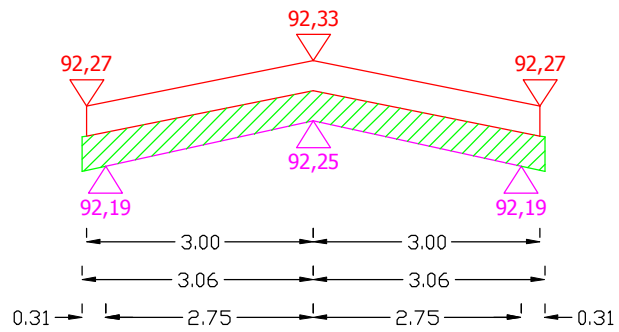

Pwyr.=0,2617 m²

0+964

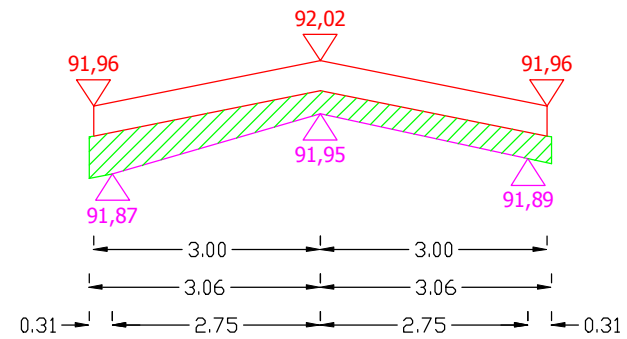

Pwyr.=0,2342 m²

0+974

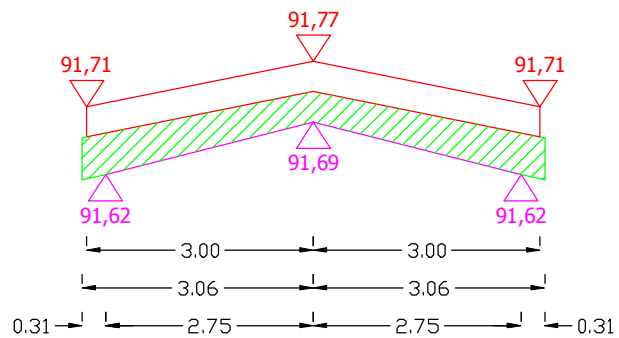

Pwyr.=0,2954 m²

0+984

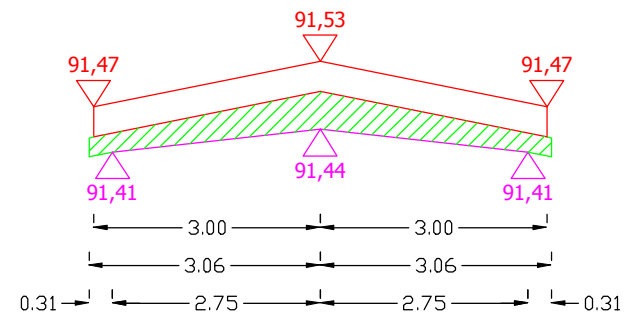

Pwyr.=0,2218 m²

Sporządził:

PRZEKROJE POPRZECZNE DROGI WOJEWÓDZKIEJ NR 651 OD KM 59+676 DO KM 61+300

SKALA 1:10/100

0+994

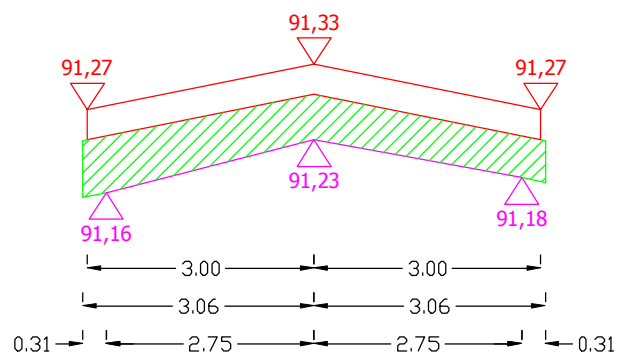

$P_{wyr.} = 0,3841 \text{ m}^2$

1+004

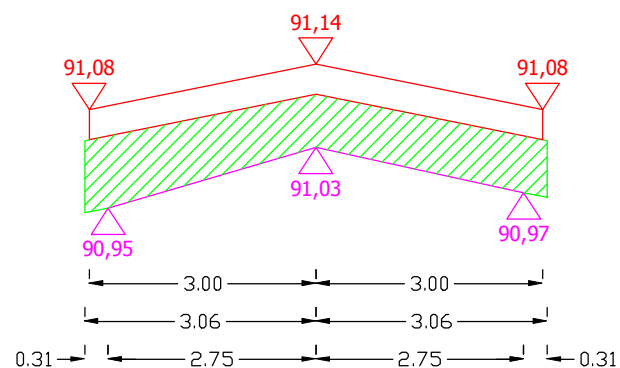

$P_{wyr.} = 0,4790 \text{ m}^2$

1+014

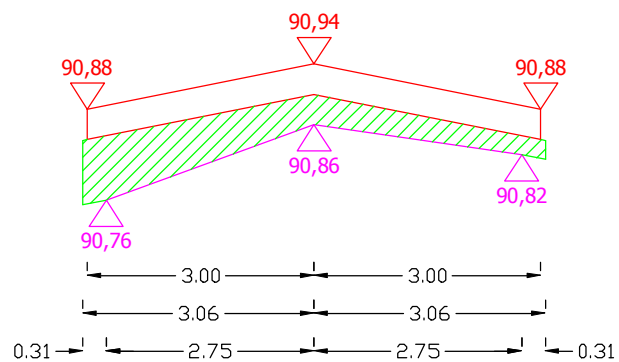

$P_{wyr.} = 0,2954 \text{ m}^2$

1+024

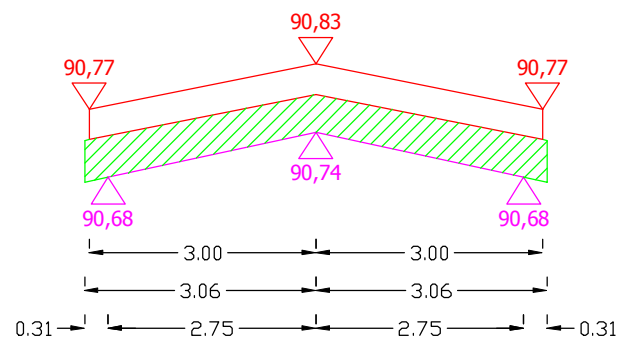

$P_{wyr.} = 0,3229 \text{ m}^2$

Sporządził:

PRZEKROJE POPRZECZNE DROGI WOJEWÓDZKIEJ NR 651 OD KM 59+676 DO KM 61+300

SKALA 1:10/100

1+034

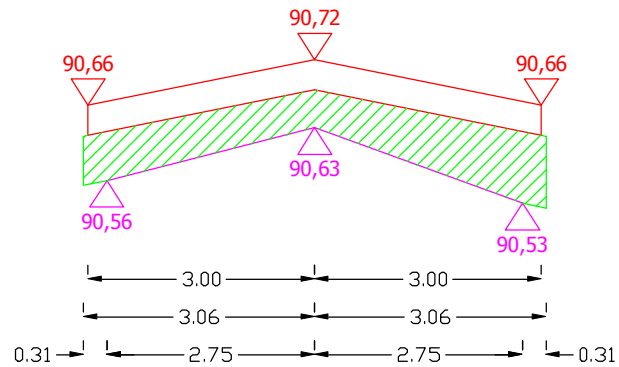

Pwyr.=0,4071 m²

1+044

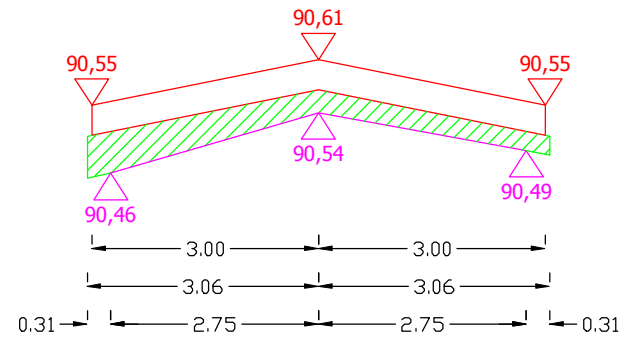

Pwyr.=0,2173 m²

1+054

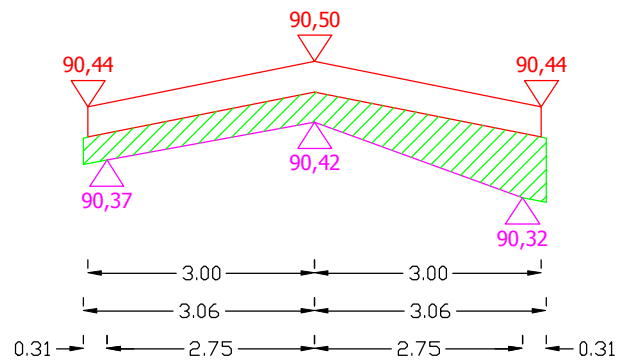

Pwyr.=0,3122 m²

1+064

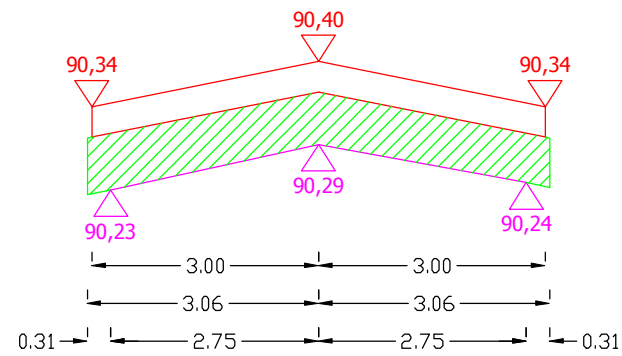

Pwyr.=0,4284 m²

Sporządził:

PRZEKROJE POPRZECZNE DROGI WOJEWÓDZKIEJ NR 651 OD KM 59+676 DO KM 61+300

SKALA 1:10/100

1+074

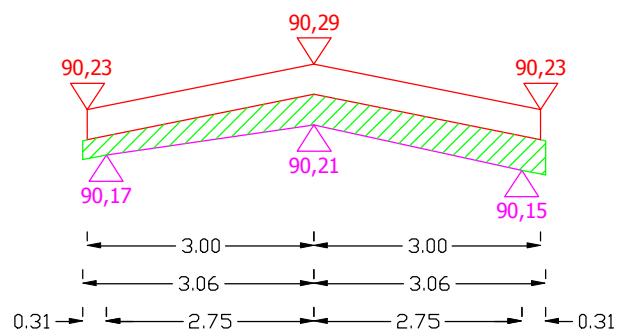

Pwyr.=0,2280 m²

1+084

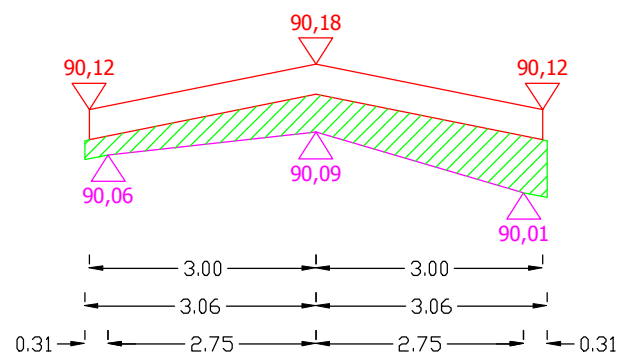

Pwyr.=0,3060 m²

1+094

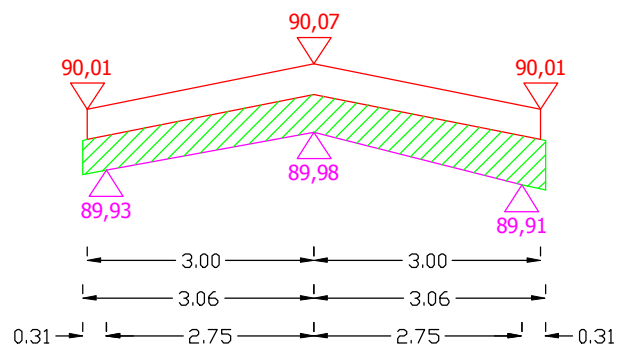

Pwyr.=0,3229 m²

1+104

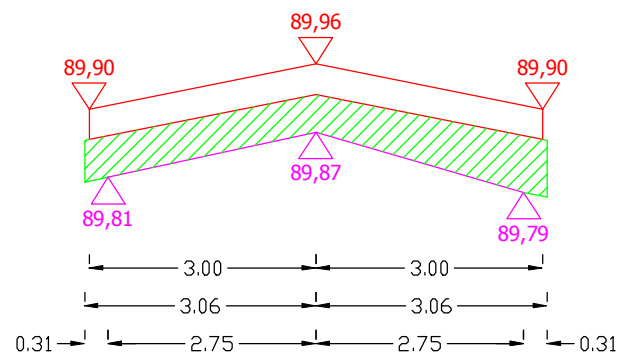

Pwyr.=0,3566 m²

Sporządził:

PRZEKROJE POPRZECZNE DROGI WOJEWÓDZKIEJ NR 651 OD KM 59+676 DO KM 61+300

SKALA 1:10/100

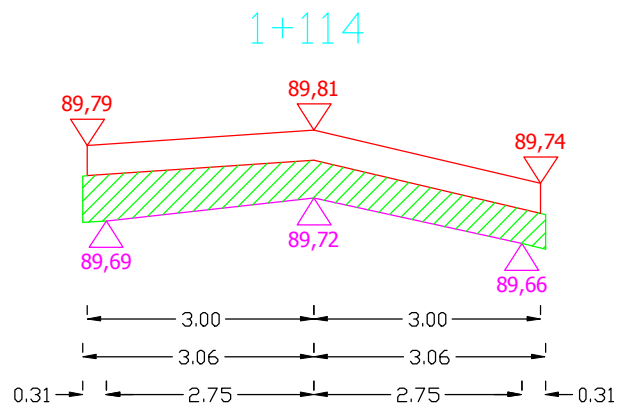

Pwyr.=0,3186 m²

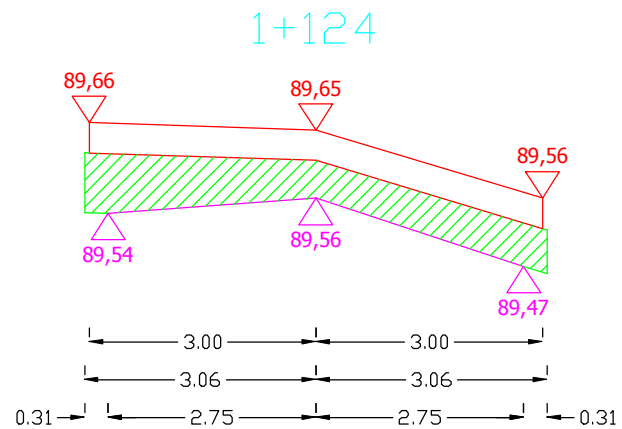

Pwyr.=0,3678 m²

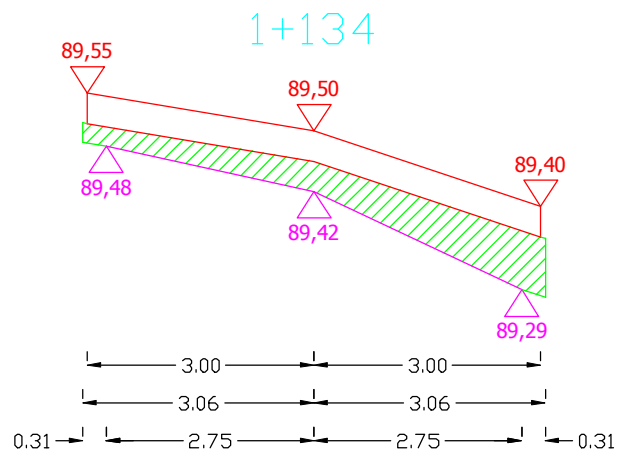

Pwyr.=0,2855 m²

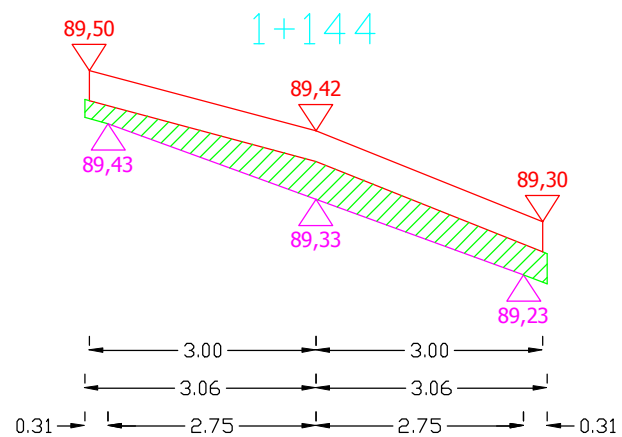

Pwyr.=0,2442 m²

Sporządził:

PRZEKROJE POPRZECZNE DROGI WOJEWÓDZKIEJ NR 651 OD KM 59+676 DO KM 61+300

SKALA 1:10/100

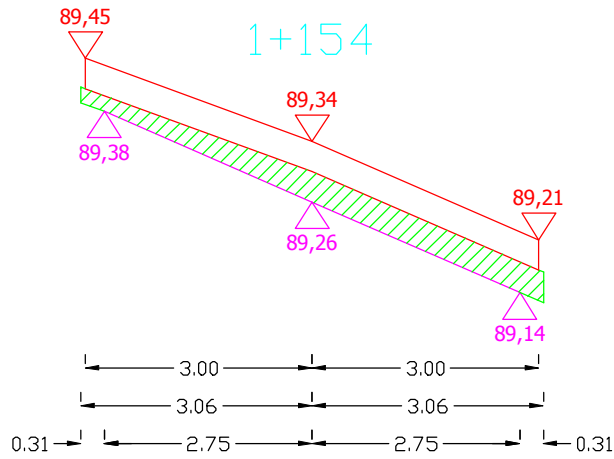

$P_{wyr.}=0,2139 \text{ m}^2$

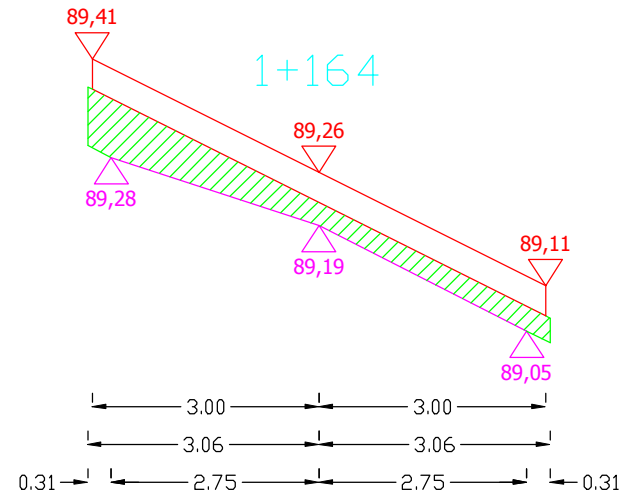

$P_{wyr.}=0,2678 \text{ m}^2$

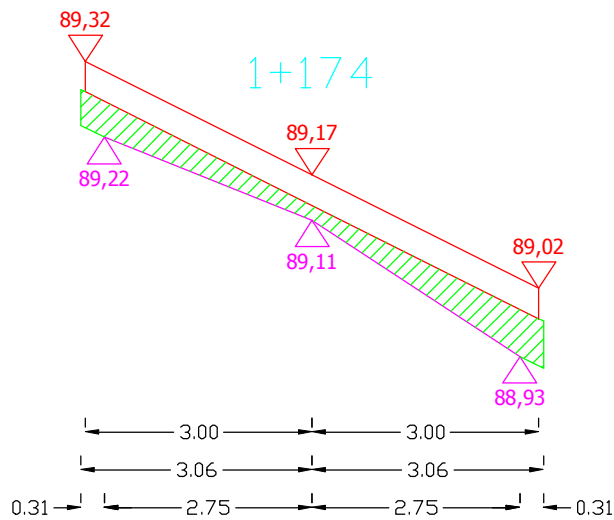

$P_{wyr.}=0,2403 \text{ m}^2$

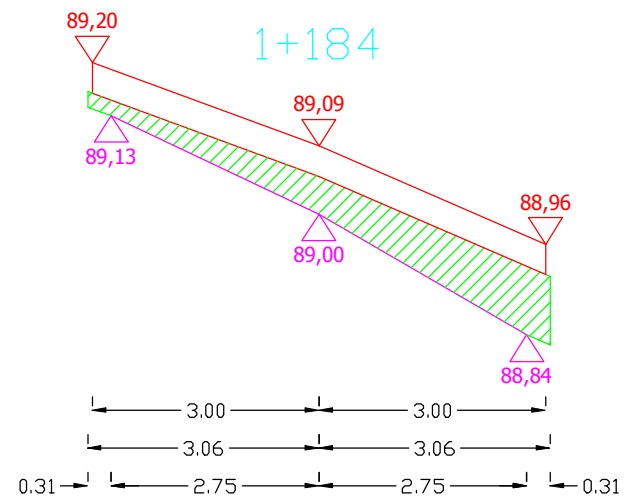

$P_{wyr.}=0,3257 \text{ m}^2$

Sporządził:

PRZEKROJE POPRZECZNE DROGI WOJEWÓDZKIEJ NR 651 OD KM 59+676 DO KM 61+300

SKALA 1:10/100

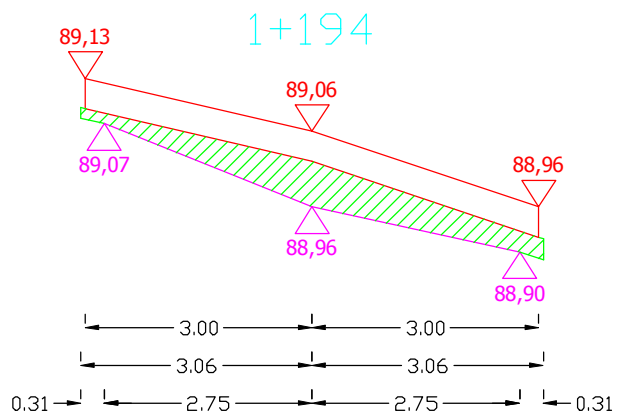

Pwyr.=0,2366 m²

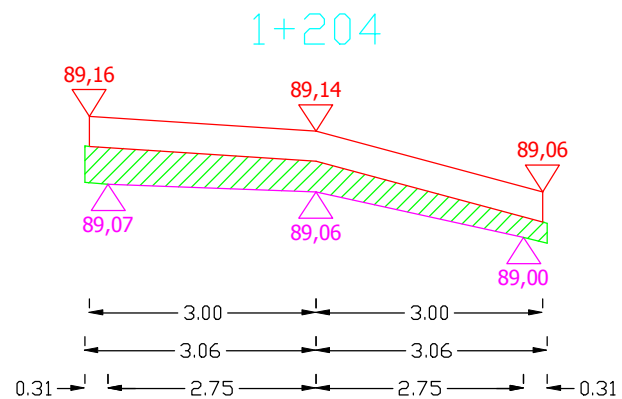

Pwyr.=0,2364 m²

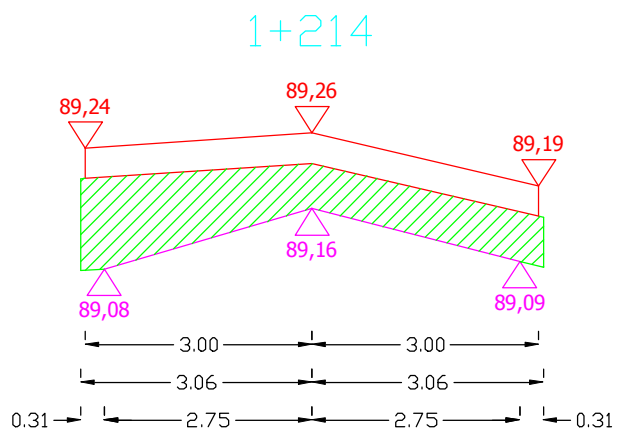

Pwyr.=0,4809 m²

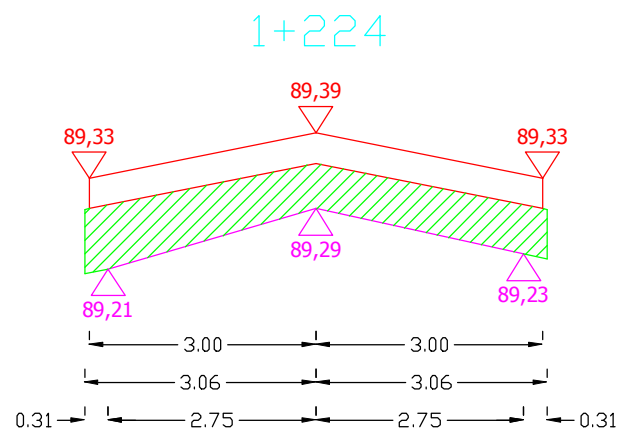

Pwyr.=0,4178 m²

Sporządził:

PRZEKROJE POPRZECZNE DROGI WOJEWÓDZKIEJ NR 651 OD KM 59+676 DO KM 61+300

SKALA 1:10/100

1+234

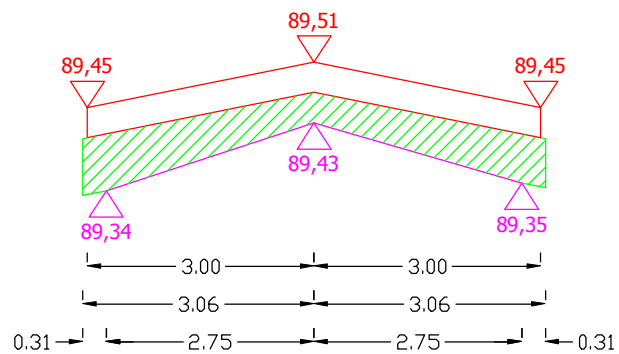

Pwyr.=0,3459 m²

1+244

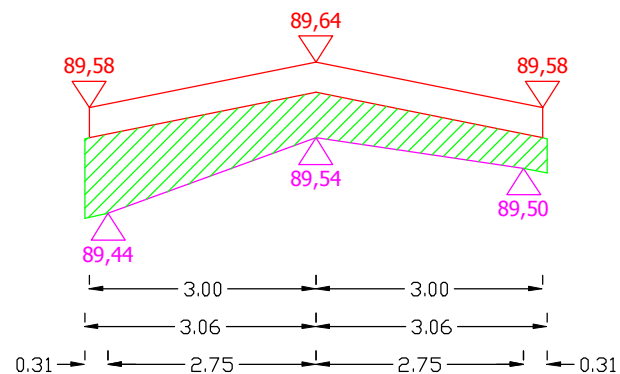

Pwyr.=0,4178 m²

1+254

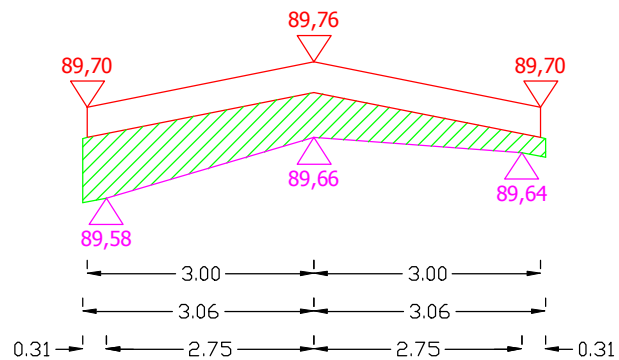

Pwyr.=0,3504 m²

1+264

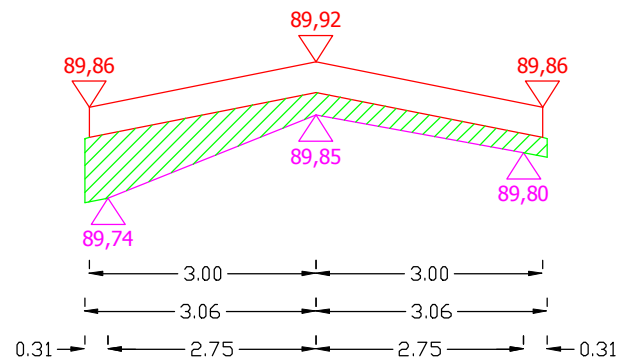

Pwyr.=0,2679 m²

Sporządził:

PRZEKROJE POPRZECZNE DROGI WOJEWÓDZKIEJ NR 651 OD KM 59+676 DO KM 61+300

SKALA 1:10/100

1+274

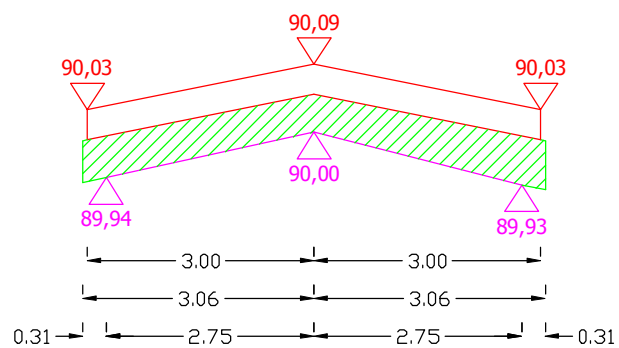

Pwyr.=0,3397 m²

1+284

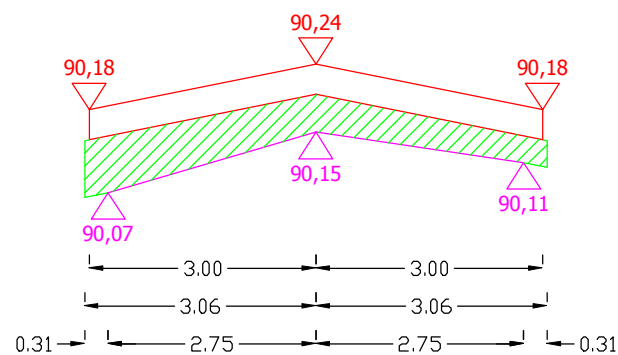

Pwyr.=0,3229 m²

1+294

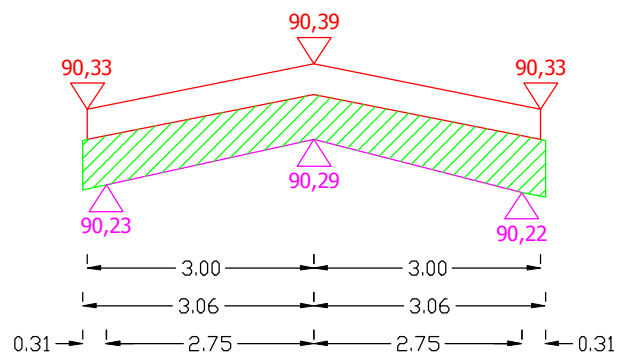

Pwyr.=0,4009 m²

1+304

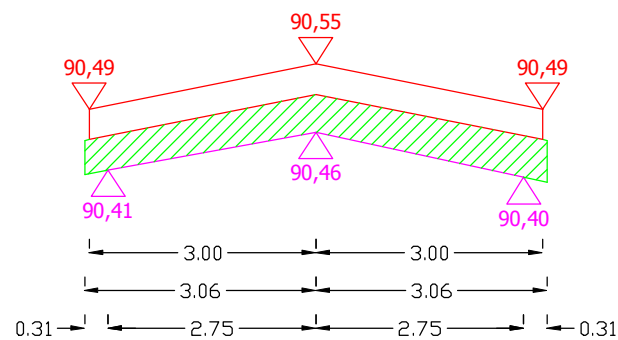

Pwyr.=0,3060 m²

Sporządził:

PRZEKROJE POPRZECZNE DROGI WOJEWÓDZKIEJ NR 651 OD KM 59+676 DO KM 61+300

SKALA 1:10/100

1+314

Pwyr.=0,2280 m²

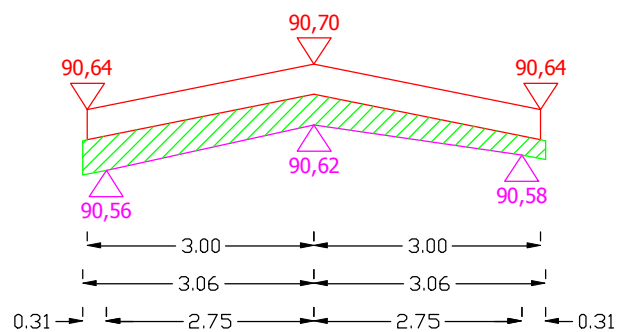

1+324

Pwyr.=0,1943 m²

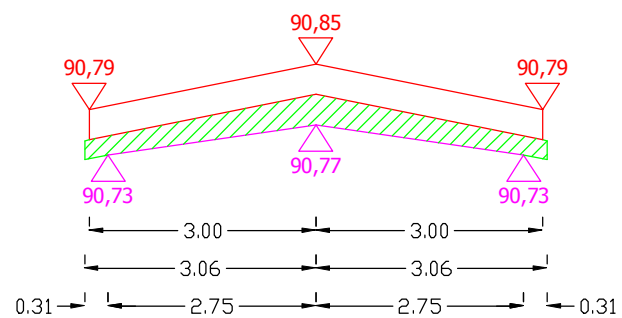

1+334

Pwyr.=0,2510 m²

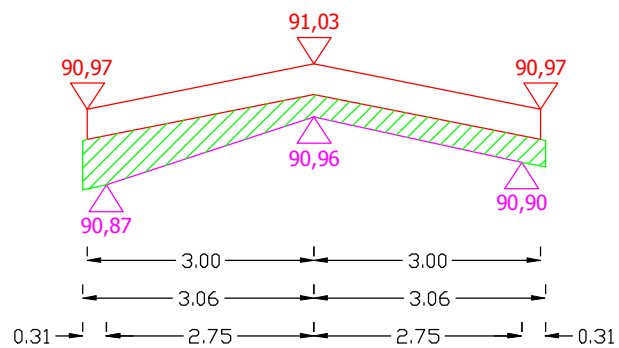

1+344

Pwyr.=0,4071 m²

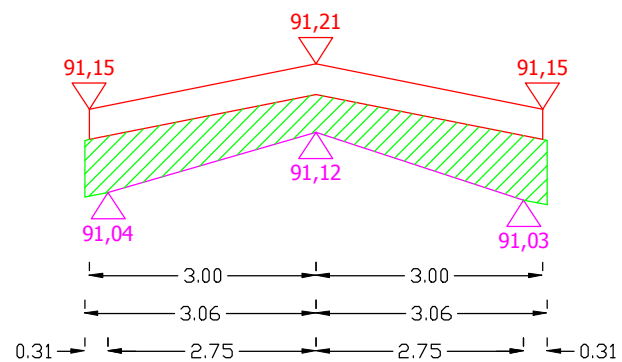

Sporządził:

PRZEKROJE POPRZECZNE DROGI WOJEWÓDZKIEJ NR 651 OD KM 59+676 DO KM 61+300

SKALA 1:10/100

1+354

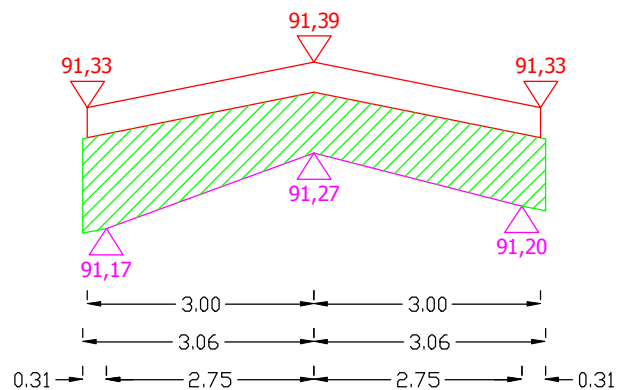

Pwyr.=0,5907 m²

1+364

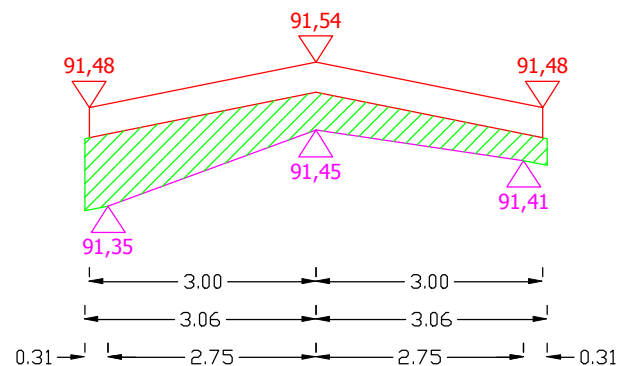

Pwyr.=0,3566 m²

1+374

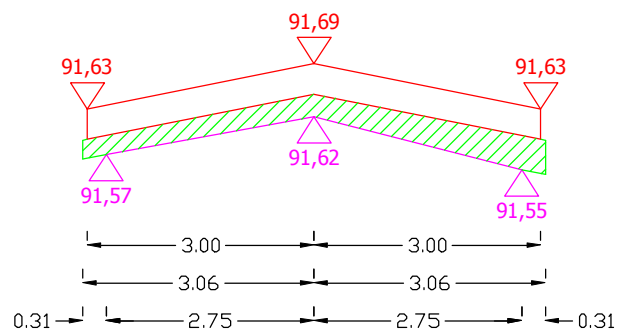

Pwyr.=0,2005 m²

1+384

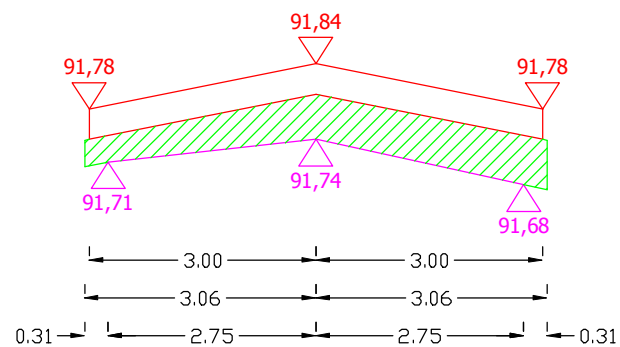

Pwyr.=0,3335 m²

Sporządził:

PRZEKROJE POPRZECZNE DROGI WOJEWÓDZKIEJ NR 651 OD KM 59+676 DO KM 61+300

SKALA 1:10/100

1+394

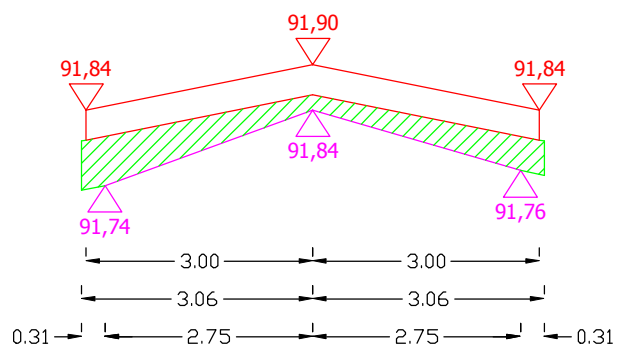

Pwyr.=0,2404 m²

1+404

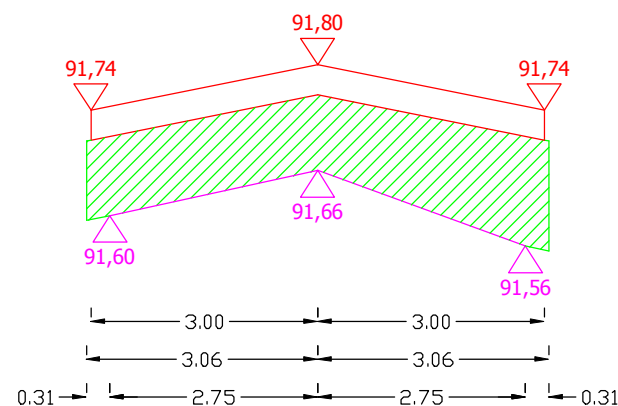

Pwyr.=0,6963 m²

1+414

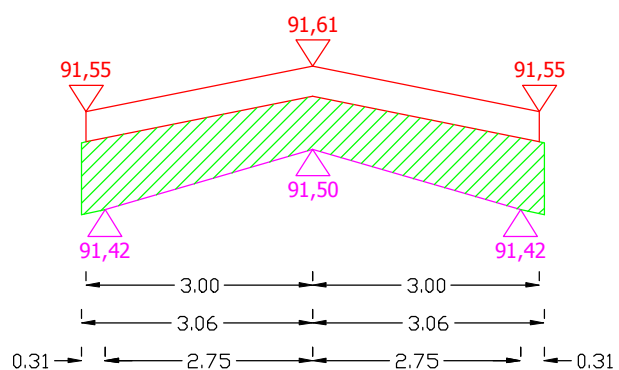

Pwyr.=0,5127 m²

1+424

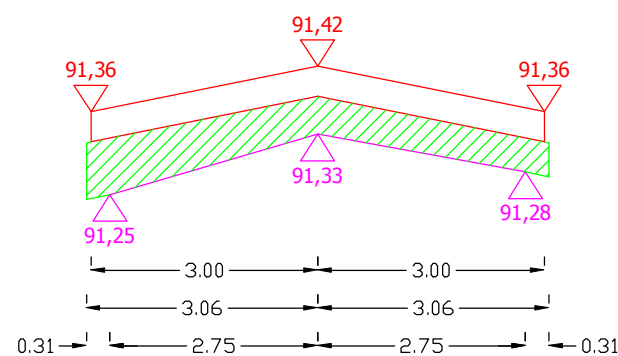

Pwyr.=0,3397 m²

Sporządził:

PRZEKROJE POPRZECZNE DROGI WOJEWÓDZKIEJ NR 651 OD KM 59+676 DO KM 61+300

SKALA 1:10/100

1+434

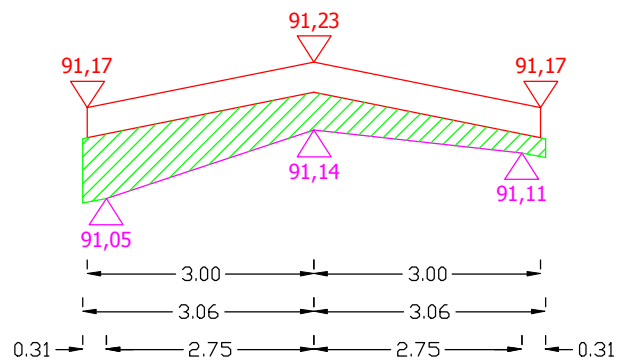

Pwyr.=0,3229 m²

1+444

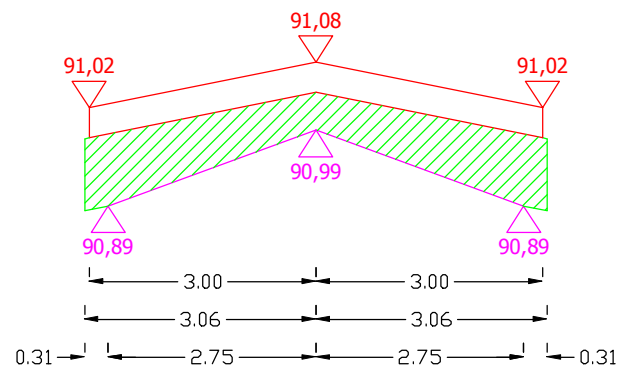

Pwyr.=0,4577 m²

1+454

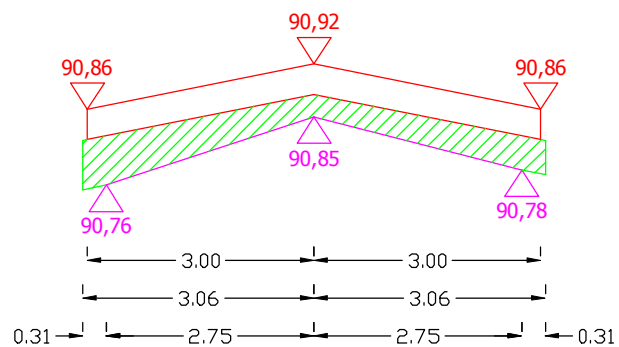

Pwyr.=0,2679 m²

1+464

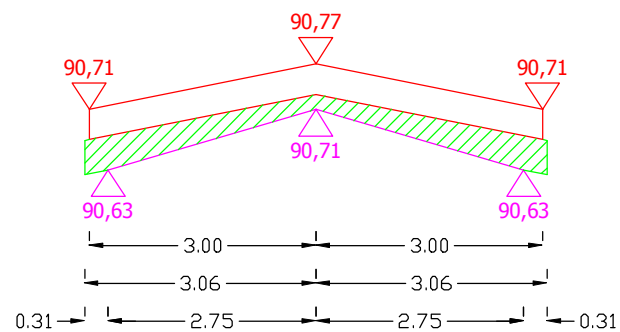

Pwyr.=0,2067 m²

Sporządził:

PRZEKROJE POPRZECZNE DROGI WOJEWÓDZKIEJ NR 651 OD KM 59+676 DO KM 61+300

SKALA 1:10/100

1+474

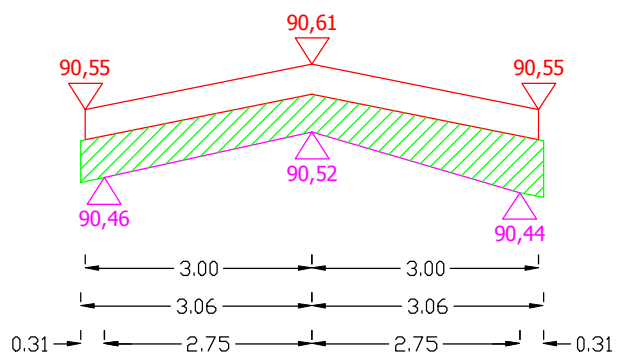

Pwyr.=0,3566 m²

1+484

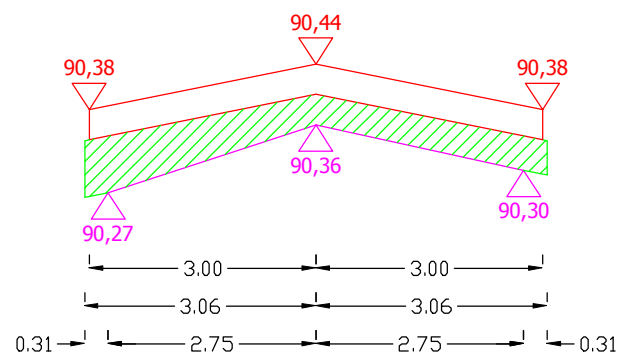

Pwyr.=0,3122 m²

1+494

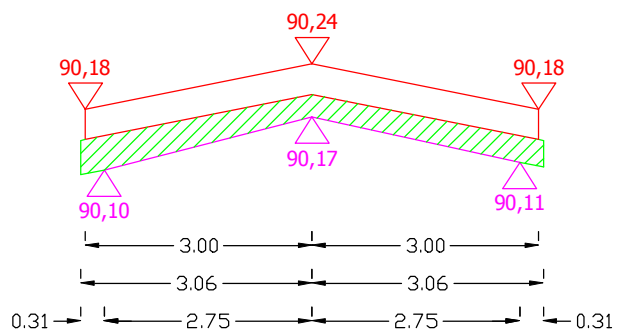

Pwyr.=0,2173 m²

1+504

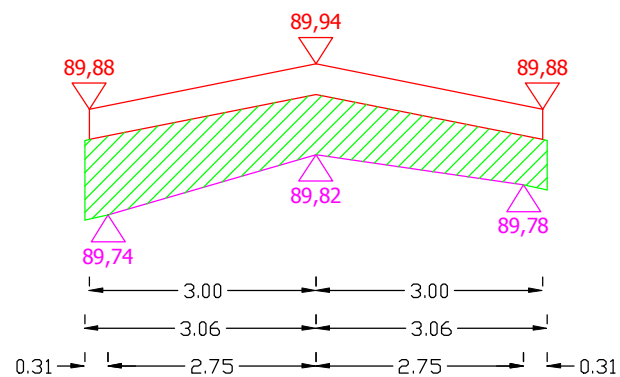

Pwyr.=0,5065 m²

Sporządził:

PRZEKROJE POPRZECZNE DROGI WOJEWÓDZKIEJ NR 651 OD KM 59+676 DO KM 61+300

SKALA 1:10/100

1+514

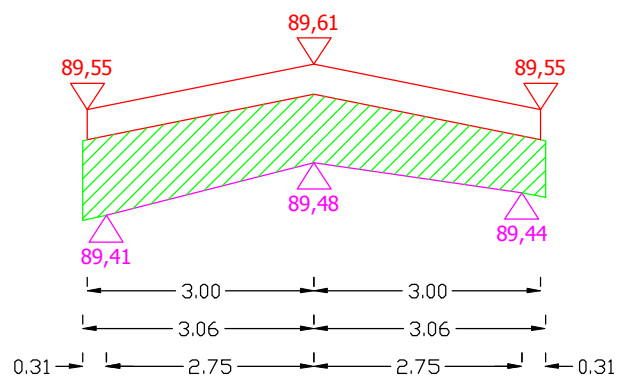

Pwyr.=0,5508 m²

1+524

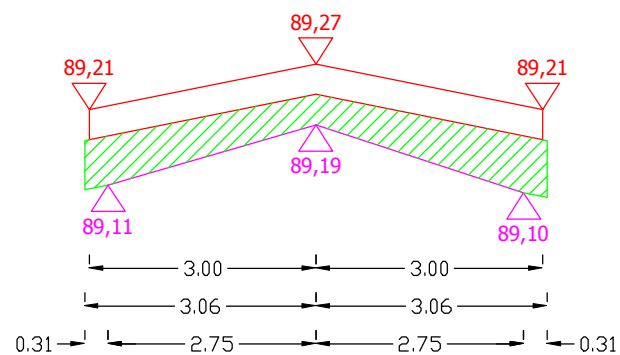

Pwyr.=0,3459 m²

1+534

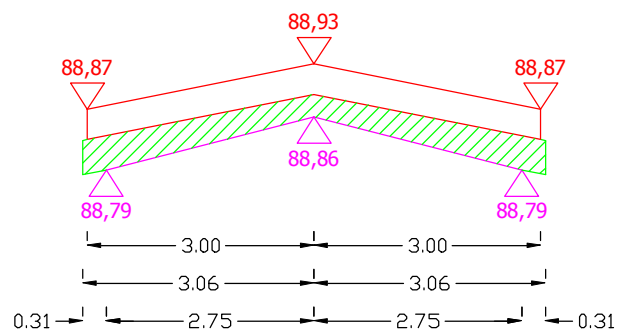

Pwyr.=0,2342 m²

1+544

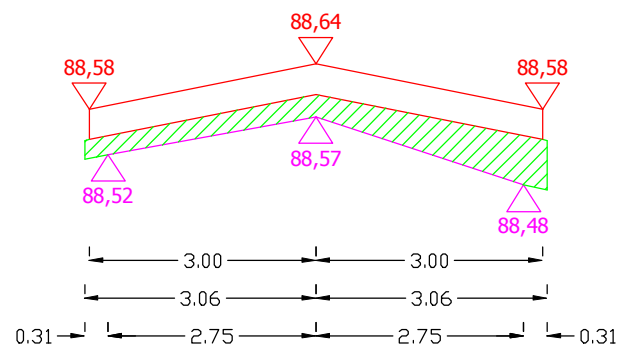

Pwyr.=0,2342 m²

Sporządził:

PRZEKROJE POPRZECZNE DROGI WOJEWÓDZKIEJ NR 651 OD KM 59+676 DO KM 61+300

SKALA 1:10/100

1+554

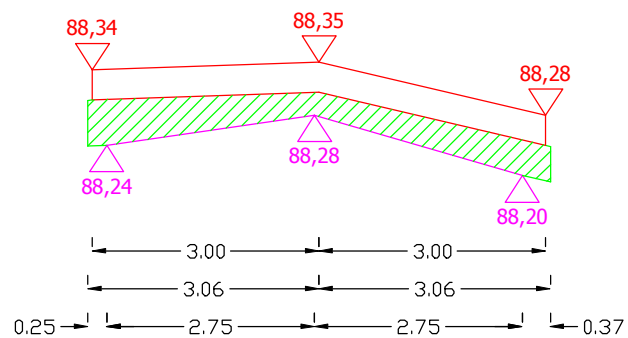

Pwyr.=0,2651 m²

1+564

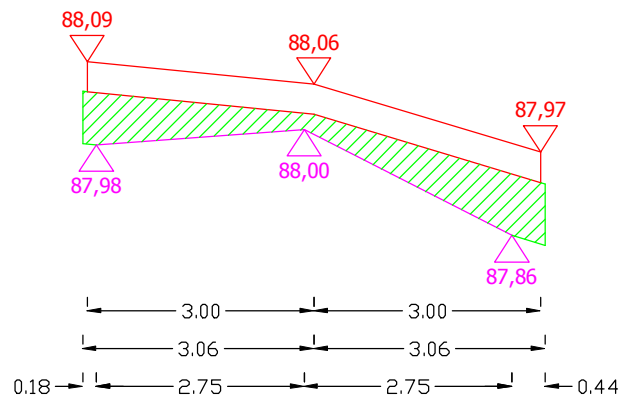

Pwyr.=0,3167 m²

1+574

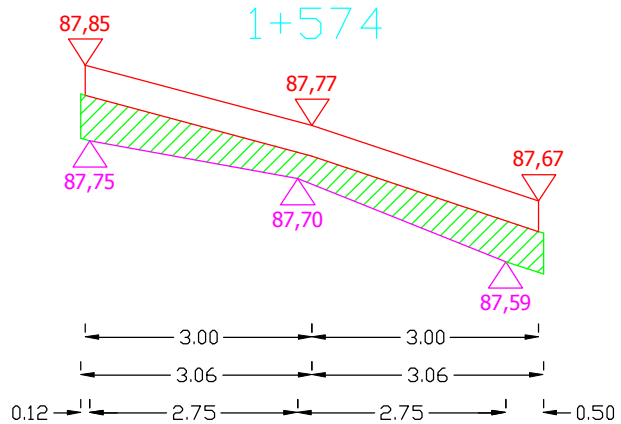

Pwyr.=0,2879 m²

1+584

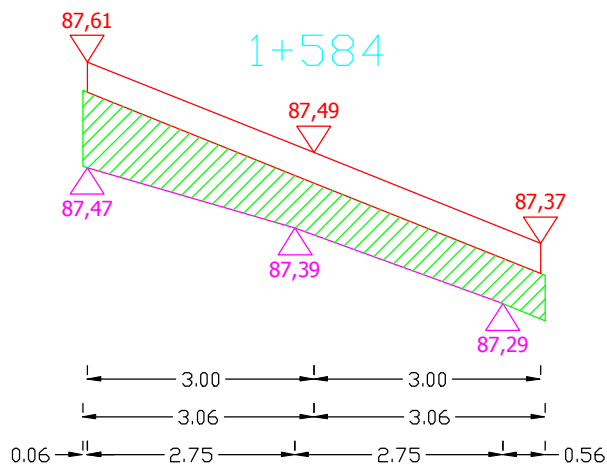

Pwyr.=0,4521 m²

Sporządził:

PRZEKROJE POPRZECZNE DROGI WOJEWÓDZKIEJ NR 651 OD KM 59+676 DO KM 61+300

SKALA 1:10/100

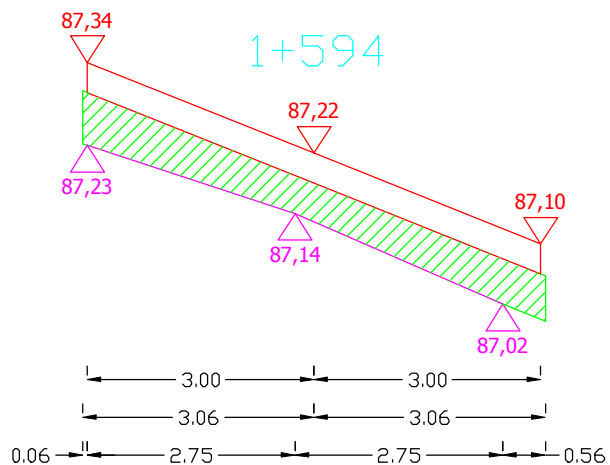

Pwyr.=0,3541 m²

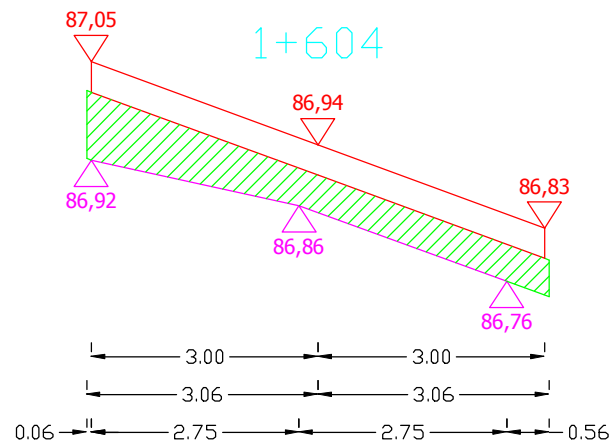

Pwyr.=0,3579 m²

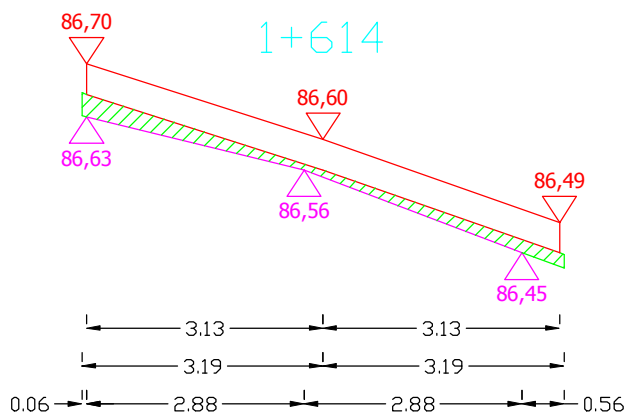

Pwyr.=0,1042 m²

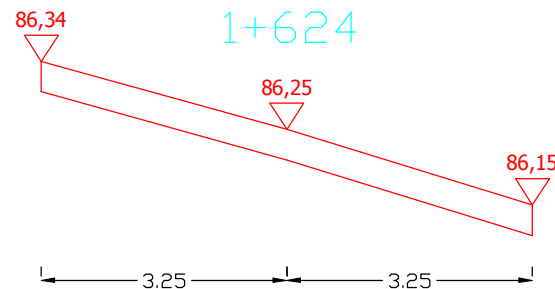

Pwyr.=0,000 m²

Sporządził: